

# Acme®

## O<sup>3</sup>zone

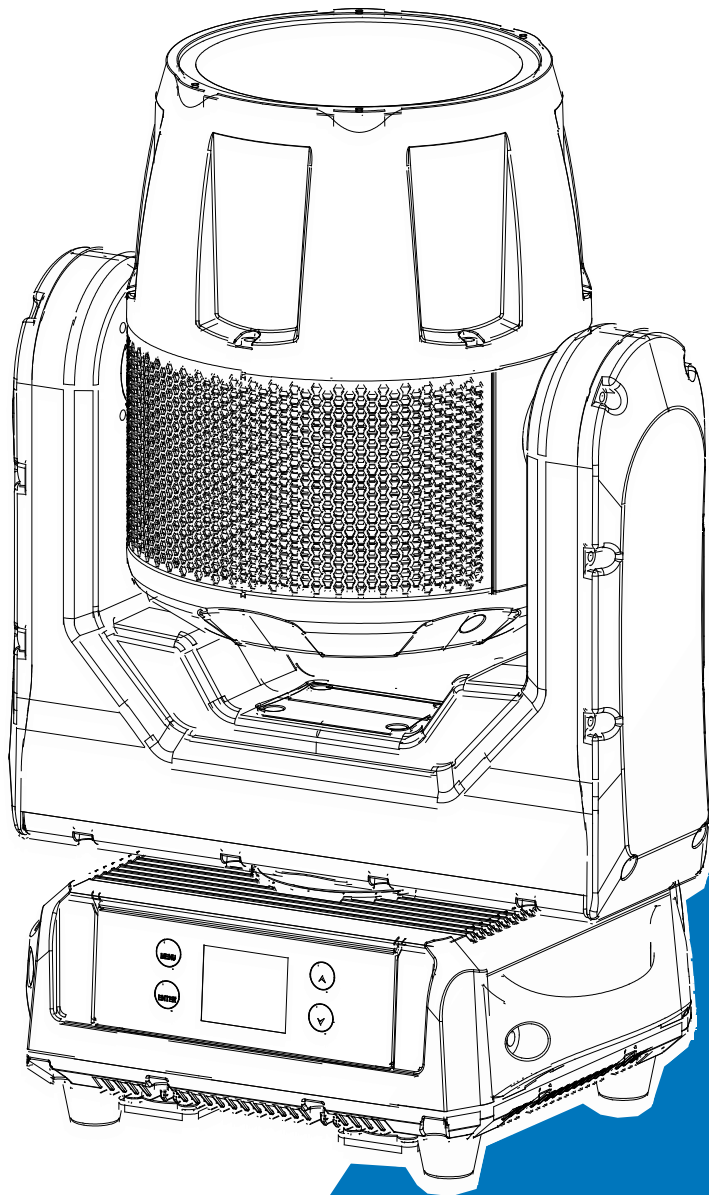

**User Manual**

Please read the instruction carefully before use

## CONTENTS

1. Safety Instructions .....	2
2. Technical Specifications .....	4
3. How To Set The Unit.....	6
3.1 Control Panel .....	6
3.2 Main Function.....	6
3.3 Home Position Adjustment .....	13
4. Control By Universal DMX Controller .....	18
4.1 DMX512 Connection .....	18
4.2 Address Setting .....	19
4.3 DMX512 Configuration.....	20
5. Error Information .....	28
6. Troubleshooting .....	29
7. Fixture Cleaning .....	30

## 1. Safety Instructions



Please read the instruction carefully which includes important information about the installation, usage and maintenance.

### WARNING

Please keep this User Guide for future consultation. If you sell the unit to another user, be sure that they also receive this instruction manual.

### Important:

**Damages caused by the disregard of this user manual are not subject to warranty. The dealer will not accept liability for any resulting defects or problems.**

- Unpack and check carefully that there is no transportation damage before using the unit.
- This product is suitable for indoor use and wet locations. Do not immerse in water.
- DO install and operate by qualified operator.
- DO NOT allow children to operate the fixture.
- Use safety chain when fixing the unit. Handle the unit by carrying its base instead of head only.
- The unit must be installed in a location with adequate ventilation, at least 50cm from adjacent surfaces.
- Be sure that no ventilation slots are blocked, otherwise the unit will be overheated.
- Before operating, ensure that the voltage and frequency of power supply match the power requirements of the unit.
- It's important to ground the yellow/green conductor to earth in order to avoid electric shock.
- Minimum ambient temperature TA: 0°C. Maximum ambient temperature TA: 40°C.
- DO NOT connect the device to any dimmer pack.
- During initial start-up some smoke or smell may arise. This is a normal process and does not necessarily mean that the device is defective, and it will decrease gradually within 15 minutes.
- Make sure there are no flammable materials close to the unit while operating to avoid fire hazard.
- Examine the power wires carefully; replace them immediately if there is any damage.
- Unit's surface temperature may reach up to 75°C. DO NOT touch the housing bare-handed during its operation.
- Avoid any inflammable liquids, water or metal objects entering the unit. Once it happens, cut

off the mains power immediately.

- DO NOT operate in dirty or dusty environment, do clean fixtures regularly.
- DO NOT touch any wire during operation as there might be a hazard of electric shock.
- Avoid power wires together twist other cables.
- The minimum distance between light output and the illuminated surface must be more than 0.5 meters.
- In the event of serious operating problem, stop using the unit immediately.
- Never turn on and off the unit time after time.
- The housing, the lenses, or the ultraviolet filter must be replaced if they are visibly damaged.
- DO NOT open the unit as there are no user serviceable parts inside.
- Never try to repair the unit by yourself. Repairs carried out by unskilled people can lead to damage or malfunction. Please contact the nearest authorized technical assistance center if needed.
- Disconnect the mains power if the fixture is has not been used for a long time.
- DO use the original packing materials before transporting it again.
- DO NOT look directly at the light while the bulb is on.
- DO NOT start on the unit without bulb enclosure or when housing is damaged.

**Installation:**

The fixture should be mounted via its Omega Quick Release Clamp bracket. Always ensure that the unit is firmly fixed to avoid vibration and slipping while operating and make sure that the structure to which you are attaching the unit is secure and is able to support a weight of 10 times of the fixtures weight. Always use a safety cable that can hold 12 times of the weight of the fixture when installing.

The equipment must be installed by professionals. It must be installed in a place where is out of the reach of people and no one can pass by or under it.

## 2. Technical Specifications

### **Power Voltage:**

AC 100~240V, 50/60Hz

### **Power Consumption:**

370W

### **Light Source:**

7x40W RGBW LED

### **Zoom Range:**

Beam Angle : 6°~40°

Field Angle : 10°~60°

### **Dimmer/Shutter:**

Smooth dimming from 0-100%; outstanding strobe effect with variable speed

### **Movement:**

Pan: 540°

Tilt: 250°

Pan/Tilt Resolution: 16bit

### **Control:**

DMX Channel: 17/37 Channels

Control Mode: DMX512, RDM

Firmware Upgrade: via DMX link & USB disk

### **Construction:**

Display: LCD Display

Data In/Out: 3-pin IP XLR

Power In/Out: Waterproof Power Connector in/out

Protection Rating: IP65

### **Features:**

Variable CTO

Pixel control, outstanding color macro effect

Motorized liner zoom system

Fast and silent operation; Flicker-free management

Protection Rating: IP65, can be used outdoors all year round

**Dimension/Weight:**

303x210x457mm, 15.8kgs

11.9"x8.3"x18" in, 34.8lbs

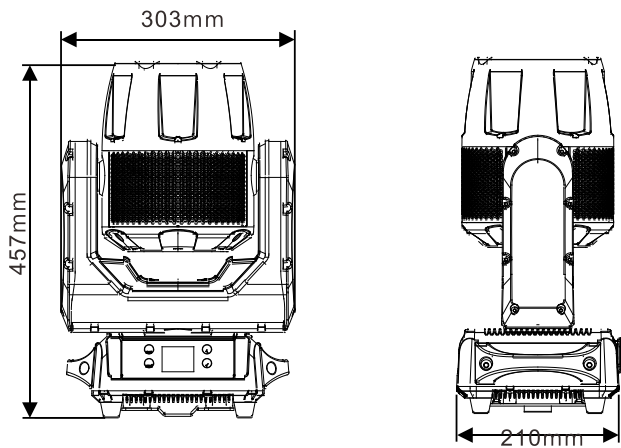

**Photometric Diagram:**

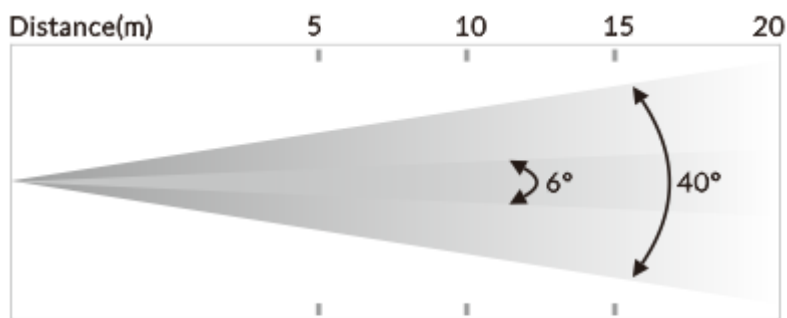

	5	10	15	20
6° Lux	5100	1350	630	318
Diameter(m)	0.5	1	1.6	2
40°Lux RGBY	336	108	85	30
Diameter(m)	3.6	7.3	10.8	14.4

### 3. How To Set The Unit

#### 3.1 Control Panel

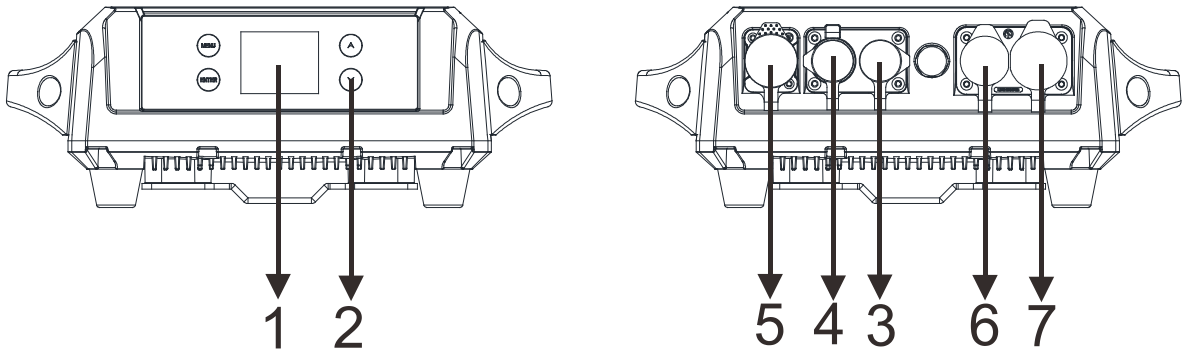

**1. Display:** To show the various menus and the selected function

**2. Button:**

<b>MENU</b>	To enter into move backward or leave the menu
<b>▲ UP</b>	To go backward to move up in the menu
<b>▼ DOWN</b>	To go forward to move down in the menu
<b>ENTER</b>	To perform the desired functions

**3. DMX IN:** DMX512 link, use 3-pin XLR cable to link the unit and DMX controller

**4. DMX OUT:** DMX512 link, use 3-pin XLR cable to link the next units

**5. FIRMWARE UPGRADE**

**6. POWER IN:** To connect to supply power

**7. POWER OUT:** To connect to the next fixture

#### 3.2 Main Function

Turn on the unit, press the **MENU** button into menu mode, and press the **UP/DOWN** button until the required function is shown on the monitor. Select the function by the **ENTER** button. Use the **UP/DOWN** button to choose the submenu, press the **ENTER** button to store and automatically return to the last menu. Press the **MENU** button or let the unit idle 30 seconds to exit menu mode.

The screen will be automatically locked if there is no operation for a long time, and can be unlocked by long-pressing the MENU button.

The main functions are shown below:

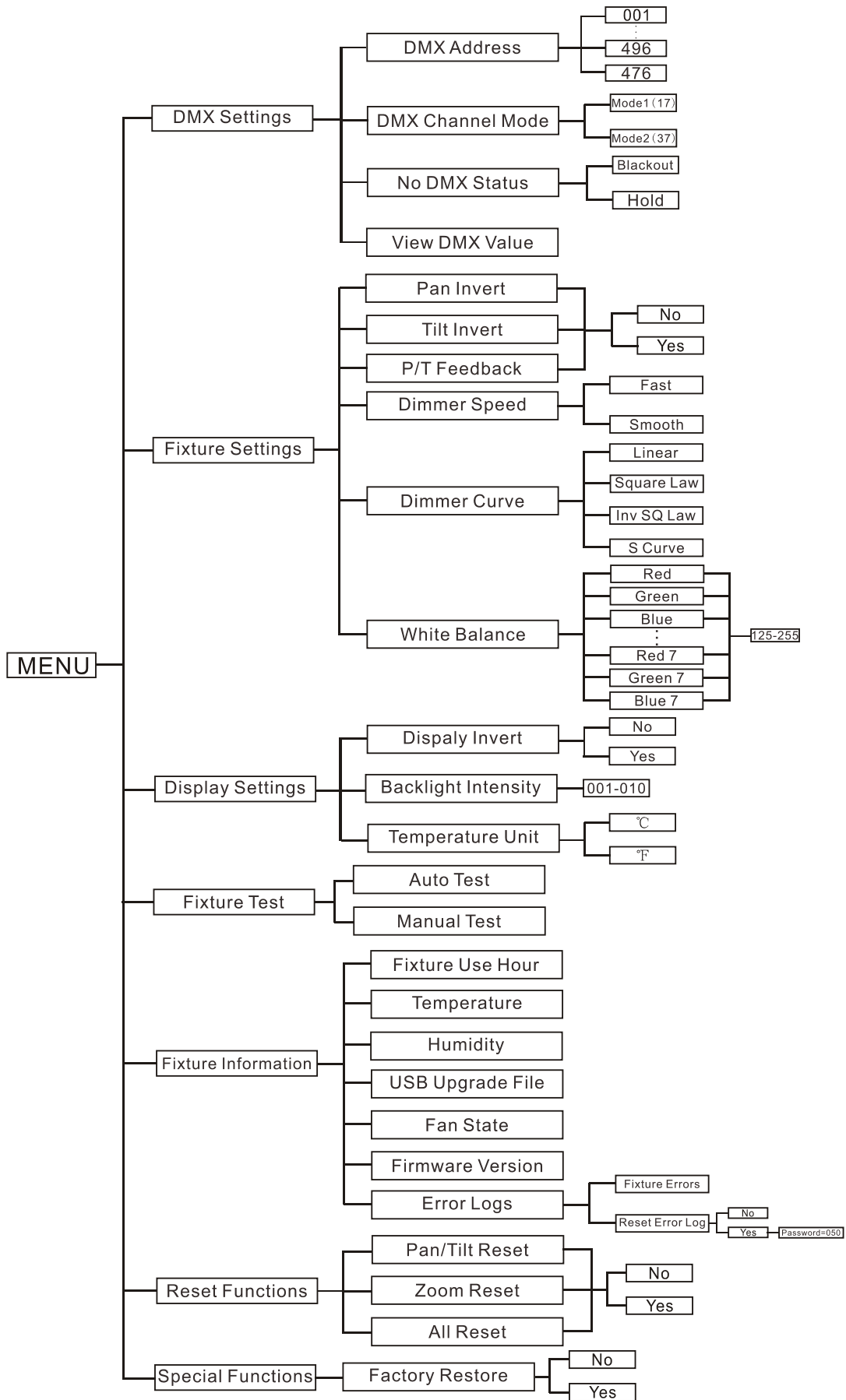



## ***DMX Settings***

To select **DMX Settings**, press the **ENTER** button to confirm, use the **UP/DOWN** button to select **DMX Address, DMX Channel Mode, No DMX Status** or **View DMX Value**.

### **DMX Address**

To select **DMX Address**, press the **ENTER** button to confirm. Use the **UP/DOWN** button to adjust the address from **001** to **496/476**, press the **ENTER** button to store. Press the **MENU** button back to the last menu or let the unit idle 30 seconds to exit menu mode.

### **DMX Channel Mode**

To select **DMX Channel Mode**, press the **ENTER** button to confirm. Use the **UP/DOWN** button to select **Mode1 (17)** or **Mode2 (37)**, press the **ENTER** button to store. Press the **MENU** button back to the last menu or let the unit idle 30 seconds to exit menu mode.

### **No DMX Status**

To select **No DMX Status**, press the **ENTER** button to confirm. Use the **UP/DOWN** button to select **Blackout**(fixture blacks out if DMX signal stops) or **Hold**(fixture continues to obey the last command it received Via DMX if DMX signal stops), press the **ENTER** button to store. Press the **MENU** button back to the last menu or let the unit idle 30 seconds to exit menu mode.

### **View DMX Value**

To select **View DMX Value**, press the **ENTER** button to confirm. Use the **UP/DOWN** button to view the DMX channel value. Press the **MENU** button back to the last menu or let the unit idle 30 seconds to exit menu mode.

## ***Fixture Settings***

To select **Fixture Settings**, press the **ENTER** button to confirm, use the **UP/DOWN** button to select **Pan Invert, Tile Invert, P/T Feedback, Dimmer Speed, Dimmer Curve** or **White Balance**.

### **Pan Invert**

To select **Pan Invert**, press the **ENTER** button to confirm. Use the **UP/DOWN** button to select **No**(normal) or **Yes**(pan invert), press the **ENTER** button to store. Press the **MENU** button back to the last menu or let the unit idle 30 seconds to exit menu mode.

### Tilt Invert

To select **Tilt Invert**, press the **ENTER** button to confirm. Use the **UP/DOWN** button to select **No**(normal) or **Yes**(tilt invert), press the **ENTER** button to store. Press the **MENU** button back to the last menu or let the unit idle 30 seconds to exit menu mode.

### P/T Feedback

To select **P/T Feedback**, press the **ENTER** button to confirm. Use the **UP/DOWN** button to select **No**(Pan or tilt's position will not feedback while out of step) or **Yes**(Feedback while pan/tilt out of step), press the **ENTER** button to store. Press the **MENU** button back to the last menu or let the unit idle 30 seconds to exit menu mode.

### Dimmer Speed

To select **Dimmer Speed**, press the **ENTER** button to confirm. Use the **UP/DOWN** button to select **Fast** or **Smooth**, press the **ENTER** button to store. Press the **MENU** button back to the last menu or let the unit idle 30 seconds to exit menu mode.

### Dimmer Curve

To select **Dimmer Curve**, press the **ENTER** button to confirm. Use the **UP/DOWN** button to select **Linear**, **Square law**, **Inv SQ law** or **S Curve**, press the **ENTER** button to store. Press the **MENU** button back to the last menu or let the unit idle 30 seconds to exit menu mode.

## Dimmer Modes

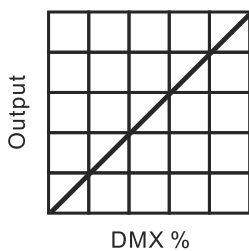

Optically Linear

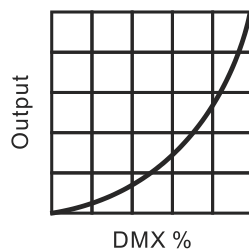

Square Law

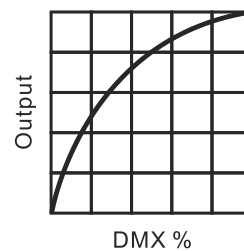

Inverse Square Law

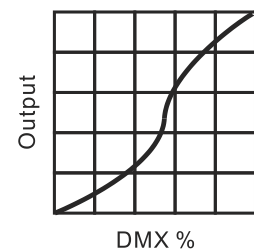

S-curve

#### Mode 1(Optically Linear):

The increase in light intensity appears to be linear as DMX value is increased.

#### Mode 2(Square Law):

Light intensity control is finer at low levels and coarser at high levels.

#### Mode 3(Inverse Square Law):

Light intensity control is coarser at low levels and finer at high levels.

#### Mode 4(S-Curve):

Light intensity control is finer at low levels and high levels and coarser at medium levels.

### **White Balance**

To select **White Balance**, press the **ENTER** button to confirm. Use the **UP/DOWN** button to select **Red, Green, Blue, Red1, Green1, Blue1,.....Red7, Green7, Blue7**, press the **ENTER** button to store. Use the **UP/DOWN** button to adjust the value from **125** to **255**, press the **ENTER** button to store. Press the **MENU** button back to the last menu or let the unit idle 30 seconds to exit menu mode.

### ***Display Settings***

To select **Display Settings**, press the **ENTER** button to confirm, use the **UP/DOWN** button to select **Display Invert, Backlight Intensity** or **Temperature Unit**.

#### **Display Invert**

Select **Display Invert**, press the **ENTER** button to confirm. Use the **UP/DOWN** button to select **No**(normal display) or **Yes**(invert display), press the **ENTER** button to store. Press the **MENU** button back to the last menu or let the unit idle 30 seconds to exit menu mode.

#### **Backlight Intensity**

Select **Backlight Intensity**, press the **ENTER** button to confirm. Use the **UP/DOWN** button to adjust the value from **001** to **010**, press the **ENTER** button to store. Press the **MENU** button back to the last menu or let the unit idle 30 seconds to exit menu mode.

#### **Temperature Unit**

Select **Temperature Unit**, press the **ENTER** button to confirm. Use the **UP/DOWN** button to select **°C** or **°F**, press the **ENTER** button to store. Press the **MENU** button back to the last menu or let the unit idle 30 seconds to exit menu mode.

### ***Fixture Test***

To select **Fixture Test**, press the **ENTER** button to confirm, use the **UP/DOWN** button to select **Auto Test** or **Manual Test**.

#### **Auto Test**

Select **Auto Test**, press the **ENTER** button to confirm, the unit will run built-in programs to automatically test. Press the **MENU** button back to the last menu or exit menu mode after auto test.

## **Manual Test**

Select **Manual Test**, press the **ENTER** button to confirm. Use the **UP/DOWN** button to select channel Pan, Pan Fine, Tilt, Tilt Fine, Zoom, Spe Func, Dimmer, Shutter, Red, Green, Blue, White, CTO, Color, Pixel or Pixel Rotating, press the **ENTER** button to confirm, then use the **UP/DOWN** button to adjust the value, press the **ENTER** button to store, the fixture will run as the channel value indicates. Press the **MENU** button back to the last menu or exit menu mode idling 30 seconds.

(All channels value will become 0 after exiting Manual Test menu)

## ***Fixture Information***

To select **Fixture Information**, press the **ENTER** button to confirm, use the **UP/DOWN** button to select **Fixture Use Hour, Temperature, Humidity, USB Upgrade File, Fan State, Firmware Version** or **Error Logs**.

### **Fixture Use Hour**

Select **Fixture Use Hour**, press the **ENTER** button to confirm, fixture use hour will show on the display, press the **MENU** button to exit.

### **Temperature**

Select **Temperature**, press the **ENTER** button to confirm, fixture temperature will show on the display, press the **MENU** button to exit.

### **Humidity**

Select **Humidity**, press the **ENTER** button to confirm, fixture humidity will show on the display, press the **MENU** button to exit.

### **USB Upgrade File**

Select **USB Upgrade File**, press the **ENTER** button to confirm, USB upgrade file will show on the display, press the **MENU** button to exit.

### **Fan State**

Select **Fan State**, press the **ENTER** button to confirm, fixture fan state will show on the display, press the **MENU** button to exit.

### **Firmware Version**

Select **Firmware Version**, press the **ENTER** button to confirm, firmware version will show on the display, press the **MENU** button back to exit.

## **Error Logs**

To select **Error Logs**, press the **ENTER** button to confirm. Use the **UP/DOWN** button to select **Fixture Errors** or **Reset Error Log**, press the **ENTER** button to store. To select **Reset Error Log**, press the **ENTER** button to confirm, use the **UP/DOWN** button to select **No** or **Yes**, press the **ENTER** button to store. To select **Yes**, press the **ENTER** button to confirm, use the **UP/DOWN** button to set the password **050**, press the **ENTER** button to reset error log. Press the **MENU** button back to the last menu or let the unit idle 30 seconds to exit menu mode.

## **Reset Functions**

To select **Reset Functions**, press the **ENTER** button to confirm, use the **UP/DOWN** button to select **Pan/Tilt Reset**, **Zoom Reset** or **All Reset**.

### **Pan/Tilt Reset**

Select **Pan/Tilt Reset**, press the **ENTER** button to confirm. Use the **UP/DOWN** button to select **No** or **Yes**, press the **ENTER** button to store. Press the **MENU** button back to the last menu or let the unit idle 30 seconds to exit menu mode.

### **Zoom Reset**

Select **Zoom Reset**, press the **ENTER** button to confirm. Use the **UP/DOWN** button to select **No** or **Yes**, press the **ENTER** button to store. Press the **MENU** button back to the last menu or let the unit idle 30 seconds to exit menu mode.

### **All Reset**

Select **All Reset**, press the **ENTER** button to confirm. Use the **UP/DOWN** button to select **No** or **Yes**, press the **ENTER** button to store. Press the **MENU** button back to the last menu or let the unit idle 30 seconds to exit menu mode.

## **Special Functions**

### **Factory Restore**

Select **Factory Restore**, press the **ENTER** button to confirm. Use the **UP/DOWN** button to select **No**(normal) or **Yes**(the fixture will reset to factory settings), press **ENTER** button to store. Press the **MENU** button to exit.

## ***RDM FUNCTIONS***

Select the MANUFACTURER menu to display the manufacturer of the fixture.

Select the SOFTWARE VERSION menu and the program version number of the fixture will be displayed.

Select the DMX START ADDRESS menu to change the DMX 512 address (001-512).

Select the DEVICE MODEL DESCRIPTION menu to display the model of the fixture.

Select the DEVICE LABEL menu to change the model of the fixture.

Select the DMX PERSONALITY menu to set the channel mode of the fixture (17/37 channel).

Select the DMX PERSONALITY DESCRIPTION menu to display the current channel mode of the fixture.

Select the DEVICE HOURS menu to display the running time of the fixture.

Select the PAN INVERT menu and the fixture will run the pan invert mode.

Select the TILT INVERT menu and the fixture will run the tilt invert mode.

Select the RESET DEVICE menu, the WARM RESET/COLD RESET option will be displayed. When WARM RESET is selected, the fixture will start a warm reset, and exit when COLD RESET is selected.

### **3.3 Home Position Adjustment**

Press the **MENU** button into menu mode, then press the **ENTER** button for about 3 seconds into offset mode to adjust the home position. Select the function by the **ENTER** button. Use the **UP/DOWN** button to choose the submenu, press the **ENTER** button to store and automatically return to the last menu. Press **MENU** button to exit.

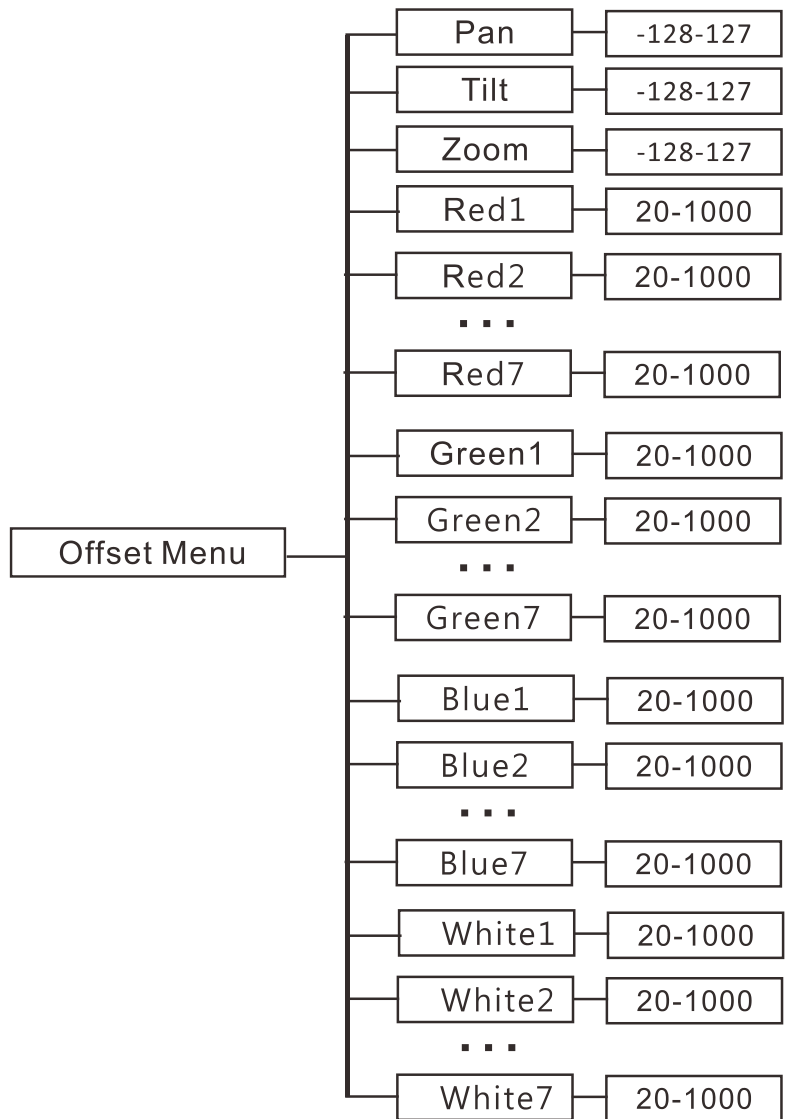

### Pan

Enter offset mode, Select **Pan**, press the **ENTER** button to confirm, the present position will blink on the display, use the **UP/DOWN** button to offset the value from -128 to 127, press the **ENTER** button to store. Press the **MENU** button to exit.

### Tilt

Enter offset mode, Select **Tilt**, press the **ENTER** button to confirm, the present position will blink on the display, use the **UP/DOWN** button to offset the value from -128 to 127, press the **ENTER** button to store. Press the **MENU** button to exit.

### Zoom

Enter offset mode, Select **Zoom**, press the **ENTER** button to confirm, the present position will blink on the display, use the **UP/DOWN** button to offset the value from -128 to 127, press the **ENTER** button to store. Press the **MENU** button to exit.

### **Red1**

Enter offset mode, Select **Red1**, press the **ENTER** button to confirm, the present position will blink on the display, use the **UP/DOWN** button to offset the value from 20 to 1000, press the **ENTER** button to store. Press the **MENU** button to exit.

### **Red2**

Enter offset mode, Select **Red2**, press the **ENTER** button to confirm, the present position will blink on the display, use the **UP/DOWN** button to offset the value from 20 to 1000, press the **ENTER** button to store. Press the **MENU** button to exit.

### **Red3**

Enter offset mode, Select **Red3**, press the **ENTER** button to confirm, the present position will blink on the display, use the **UP/DOWN** button to offset the value from 20 to 1000, press the **ENTER** button to store. Press the **MENU** button to exit.

### **Red4**

Enter offset mode, Select **Red4**, press the **ENTER** button to confirm, the present position will blink on the display, use the **UP/DOWN** button to offset the value from 20 to 1000, press the **ENTER** button to store. Press the **MENU** button to exit.

### **Red5**

Enter offset mode, Select **Red5**, press the **ENTER** button to confirm, the present position will blink on the display, use the **UP/DOWN** button to offset the value from 20 to 1000, press the **ENTER** button to store. Press the **MENU** button to exit.

### **Red6**

Enter offset mode, Select **Red6**, press the **ENTER** button to confirm, the present position will blink on the display, use the **UP/DOWN** button to offset the value from 20 to 1000, press the **ENTER** button to store. Press the **MENU** button to exit.

### **Red7**

Enter offset mode, Select **Red7**, press the **ENTER** button to confirm, the present position will blink on the display, use the **UP/DOWN** button to offset the value from 20 to 1000, press the **ENTER** button to store. Press the **MENU** button to exit.

### **Green1**

Enter offset mode, Select **Green1**, press the **ENTER** button to confirm, the present position will blink on the display, use the **UP/DOWN** button to offset the value from 20 to 1000, press the **ENTER** button to store. Press the **MENU** button to exit.



### **Green2**

Enter offset mode, Select **Green2**, press the **ENTER** button to confirm, the present position will blink on the display, use the **UP/DOWN** button to offset the value from 20 to 1000, press the **ENTER** button to store. Press the **MENU** button to exit.

### **Green3**

Enter offset mode, Select **Green3**, press the **ENTER** button to confirm, the present position will blink on the display, use the **UP/DOWN** button to offset the value from 20 to 1000, press the **ENTER** button to store. Press the **MENU** button to exit.

### **Green4**

Enter offset mode, Select **Green4**, press the **ENTER** button to confirm, the present position will blink on the display, use the **UP/DOWN** button to offset the value from 20 to 1000, press the **ENTER** button to store. Press the **MENU** button to exit.

### **Green5**

Enter offset mode, Select **Green5**, press the **ENTER** button to confirm, the present position will blink on the display, use the **UP/DOWN** button to offset the value from 20 to 1000, press the **ENTER** button to store. Press the **MENU** button to exit.

### **Green6**

Enter offset mode, Select **Green6**, press the **ENTER** button to confirm, the present position will blink on the display, use the **UP/DOWN** button to offset the value from 20 to 1000, press the **ENTER** button to store. Press the **MENU** button to exit.

### **Green7**

Enter offset mode, Select **Green7**, press the **ENTER** button to confirm, the present position will blink on the display, use the **UP/DOWN** button to offset the value from 20 to 1000, press the **ENTER** button to store. Press the **MENU** button to exit.

### **Blue1**

Enter offset mode, Select **Blue1**, press the **ENTER** button to confirm, the present position will blink on the display, use the **UP/DOWN** button to offset the value from 20 to 1000, press the **ENTER** button to store. Press the **MENU** button to exit.

### **Blue2**

Enter offset mode, Select **Blue2**, press the **ENTER** button to confirm, the present position will blink on the display, use the **UP/DOWN** button to offset the value from 20 to 1000, press the **ENTER** button to store. Press the **MENU** button to exit.

### **Blue3**

Enter offset mode, Select **Blue3**, press the **ENTER** button to confirm, the present position will blink on the display, use the **UP/DOWN** button to offset the value from 20 to 1000, press the **ENTER** button to store. Press the **MENU** button to exit.

### **Blue4**

Enter offset mode, Select **Blue4**, press the **ENTER** button to confirm, the present position will blink on the display, use the **UP/DOWN** button to offset the value from 20 to 1000, press the **ENTER** button to store. Press the **MENU** button to exit.

### **Blue5**

Enter offset mode, Select **Blue5**, press the **ENTER** button to confirm, the present position will blink on the display, use the **UP/DOWN** button to offset the value from 20 to 1000, press the **ENTER** button to store. Press the **MENU** button to exit.

### **Blue6**

Enter offset mode, Select **Blue6**, press the **ENTER** button to confirm, the present position will blink on the display, use the **UP/DOWN** button to offset the value from 20 to 1000, press the **ENTER** button to store. Press the **MENU** button to exit.

### **Blue7**

Enter offset mode, Select **Blue7**, press the **ENTER** button to confirm, the present position will blink on the display, use the **UP/DOWN** button to offset the value from 20 to 1000, press the **ENTER** button to store. Press the **MENU** button to exit.

### **White1**

Enter offset mode, Select **White1**, press the **ENTER** button to confirm, the present position will blink on the display, use the **UP/DOWN** button to offset the value from 20 to 1000, press the **ENTER** button to store. Press the **MENU** button to exit.

### **White2**

Enter offset mode, Select **White2**, press the **ENTER** button to confirm, the present position will blink on the display, use the **UP/DOWN** button to offset the value from 20 to 1000, press the **ENTER** button to store. Press the **MENU** button to exit.

### **White3**

Enter offset mode, Select **White3**, press the **ENTER** button to confirm, the present position will blink on the display, use the **UP/DOWN** button to offset the value from 20 to 1000, press the **ENTER** button to store. Press the **MENU** button to exit.

### White4

Enter offset mode, Select **White4**, press the **ENTER** button to confirm, the present position will blink on the display, use the **UP/DOWN** button to offset the value from 20 to 1000, press the **ENTER** button to store. Press the **MENU** button to exit.

### White5

Enter offset mode, Select **White5**, press the **ENTER** button to confirm, the present position will blink on the display, use the **UP/DOWN** button to offset the value from 20 to 1000, press the **ENTER** button to store. Press the **MENU** button to exit.

### White6

Enter offset mode, Select **White6**, press the **ENTER** button to confirm, the present position will blink on the display, use the **UP/DOWN** button to offset the value from 20 to 1000, press the **ENTER** button to store. Press the **MENU** button to exit.

### White7

Enter offset mode, Select **White7**, press the **ENTER** button to confirm, the present position will blink on the display, use the **UP/DOWN** button to offset the value from 20 to 1000, press the **ENTER** button to store. Press the **MENU** button to exit.

## 4. Control By Universal DMX Controller

### 4.1 DMX512 Connection

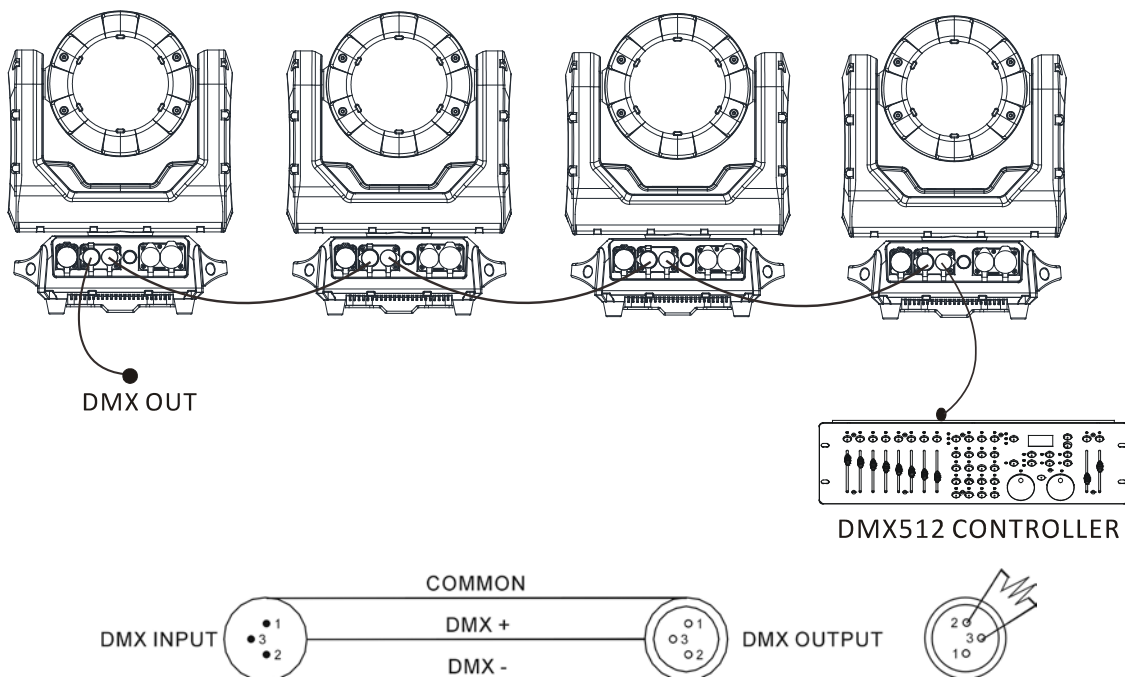

1. At last unit, the DMX cable has to be terminated with a terminator. Solder a 120-ohm 1/4W resistor between pin 2(DMX-) and pin 3(DMX+) into a 3-pin XLR-plug and plug it in the DMX-output of the last unit.
  2. Connect the unit together in a “daisy chain” by XLR plug cable from the output of the unit to the input of the next unit. The cable cannot be branched or split to a “Y” cable. DMX 512 is a very high-speed signal. Inadequate or damaged cables, soldered joints or corroded connectors can easily distort the signal and shut down the system.
  3. The DMX output and input connectors are pass-through to maintain the DMX circuit, when one of the units’ power is disconnected.
  4. Each lighting unit needs to have a DMX address to receive the data by the controller. The address number is between 1-512.
  5. The end of the DMX 512 system should be terminated to reduce signal errors.
  6. 3 pin XLR connectors are more popular than 5 pins XLR.
- 3 pin XLR: Pin 1: GND, Pin 2: Negative signal (-), Pin 3: Positive signal (+)
- 5 pin XLR: Pin 1: GND, Pin 2: Negative signal (-), Pin 3: Positive signal (+), Pin4, Pin5 not used.

## 4.2 Address Setting

If you use a universal DMX controller to control the units, you have to set DMX address from 1 to 512 so that the units can receive DMX signal.

Press the MENU button to enter menu mode, select DMX Settings, press the ENTER button to confirm, use the UP/DOWN button to select DMX Address, press the ENTER button to confirm, the present address will blinking the display, use the UP/DOWN button to adjust the address from 001 to 512, press the ENTER button to store. Press the MENU button back to the last menu or idling let the unit idle 30 seconds to exit menu mode.

Please refer to the following diagram to address your DMX512 channel for the first 4 units.

Channel mode	Unit 1 Address	Unit 2 Address	Unit 3 Address	Unit 4 Address
17 channels	1	18	35	52
37 channels	1	38	75	112

## 4.3 DMX512 Configuration

Please refer to below configurations to control the fixtures

### Attentions:

1. The unit will maintain the last condition until reset if you cut-off the DMX signal.
2. For the channel Function, keep the value for about 3 seconds, then the corresponding function will take into effect.

### 17 Channels (Mode 1):

CHANNEL	VALUE	FUNCTION
1	000-255	<b>PAN</b> 0°→540°
2	000-255	<b>PAN FINE</b>
3	000-255	<b>TILT</b> 0°→250°
4	000-255	<b>TILT FINE</b>
5	000-255	<b>ZOOM</b> Narrow→Wide
6	000-255	<b>DIMMER</b> 0%→100%
7	000-255	<b>DIMMER FINE</b>
8	000-007 008-015 016-131 132-139 140-181 182-189 190-231 232-239 240-247 248-255	<b>SHUTTER</b> Close Open Strobe effect, slow to fast Open Fast close slow open, slow to fast Open Fast open slow close, slow to fast Open Random strobe effect, slow to fast Open
9	000-255	<b>Red1</b> 0%→100%
10	000-255	<b>Green1</b> 0%→100%
11	000-255	<b>Blue1</b> 0%→100%
12	000-255	<b>White1</b> 0%→100%
13		<b>Linear CTO</b>

	000	Null
	001-004	8000K
	005-009	7900K
	010-013	7800K
	014-018	7700K
	019-022	7600K
	023-027	7500K
	028-031	7400K
	032-036	7300K
	037-040	7200K
	041-045	7100K
	046-049	7000K
	050-054	6900K
	055-058	6800K
	059-063	6700K
	064-067	6600K
	068-072	6500K
	073-076	6400K
	077-081	6300K
	082-085	6200K
	086-090	6100K
	091-094	6000K
	095-099	5900K
	100-103	5800K
	104-108	5700K
	109-112	5600K
	113-117	5500K
	118-121	5400K
	122-126	5300K
	127-130	5200K
	131-135	5100K
	136-139	5000K
	140-144	4900K
	145-148	4800K
	149-153	4700K
	154-157	4600K
	158-162	4500K
	163-166	4400K
	167-171	4300K
	172-175	4200K
	176-180	4100K
	181-184	4000K
	185-189	3900K
	190-193	3800K
	194-198	3700K
	199-202	3600K
	203-207	3500K

	208-211 212-216 217-220 221-225 226-229 230-234 235-238 239-243 244-247 248-255	3400K 3300K 3200K 3100K 3000K 2900K 2800K 2700K 2600K 2500K
14	000-007 008-011 012-015 016-019 020-023 024-027 028-031 032-035 036-039 040-043 044-047 048-051 052-055 056-059 060-063 064-067 068-071 072-075 076-079 080-083 084-087 088-091 092-095 096-099 100-103 104-107 108-111 112-115 116-119 120-123 124-127 128-131 132-135 136-165 166-195 196-205	<b>Color Macro</b> NULL Color1 Color2 Color3 Color4 Color5 Color6 Color7 Color8 Color9 Color10 Color11 Color12 Color13 Color14 Color15 Color16 Color17 Color18 Color19 Color20 Color21 Color22 Color23 Color24 Color25 Color26 Color27 Color28 Color29 Color30 Color31 Color32 Rotate CW Fast to Slow Rotate CCW Slow to Fast Red->Green Fast to Slow

	206-215 216-225 226-235 236-245 246-255	Red->Blue Fast to Slow Red->White Fast to Slow Green-> Blue Fast to Slow Green-> White Fast to Slow Blue-> White Fast to Slow
15	000-003 004-007 008-011 012-015 016-019 020-023 024-027 028-031 032-035 036-039 040-043 044-047 048-051 052-055 056-059 060-063 064-067 068-071 072-075 076-079 080-083 084-087 088-091 092-095 096-099 100-103 104-107 108-111 112-115 116-119 120-123 124-127 128-131 132-135 136-139 140-143 144-147 148-151 152-155 156-159 160-163	<b>Pixel</b> Open Pattern 1 Pattern 2 Pattern 3 Pattern 4 Pattern 5 Pattern 6 Pattern 7 Pattern 8 Pattern 9 Pattern 10 Pattern 11 Pattern 12 Pattern 13 Pattern 14 Pattern 15 Pattern 16 Pattern 17 Pattern 18 Pattern 19 Pattern 20 Pattern 21 Pattern 22 Pattern 23 Pattern 24 Pattern 25 Pattern 26 Pattern 27 Pattern 28 Pattern 29 Pattern 30 Pattern 31 Pattern 32 Pattern 33 Pattern 34 Pattern 35 Pattern 36 Pattern 37 Pattern 38 Pattern 39 Pattern 40



	164-167 168-171 172-175 176-179 180-183 184-187 188-191 192-195 196-199 200-203 204-207 208-211 212-215 216-219 220-223 224-227 228-231 232-235 236-239 240-243 244-247 248-251 252-255	Pattern 41 Pattern 42 Pattern 43 Pattern 44 Pattern 45 Pattern 46 Pattern 47 Pattern 48 Pattern 49 Pattern 50 Pattern 51 Pattern 52 Pattern 53 Pattern 54 Pattern 55 Pattern 56 Pattern 57 Pattern 58 Pattern 59 Pattern 60 Random(Pattern 1-7) Pattern 61 Open
16	000-031 032-091 092-101 102-161 162-255	<b>Pixel Rotating</b> NULL Rotate CW, fast to slow NULL Rotate CCW, slow to fast NULL
17	000-079 080-089 090-099 100-139 140-149 150-159 160-199 200-209 210-255	<b>Function</b> Null Dimmer Smooth Dimmer Fast Null Pan/Tilt Reset Zoom Reset Null Reset All Null

































































37 Channels (Mode 2):

CHANNEL	VALUE	FUNCTION
1	000-255	<b>PAN</b> 0°→540°
2	000-255	<b>PAN FINE</b>
3	000-255	<b>TILT</b> 0°→250°
4	000-255	<b>TILT FINE</b>
5	000-255	<b>ZOOM</b> Narrow→Wide
6	000-255	<b>DIMMER</b> 0%→100%
7	000-255	<b>DIMMER FINE</b>
8	000-007 008-015 016-131 132-139 140-181 182-189 190-231 232-239 240-247 248-255	<b>Shutter</b> Close Open Strobe effect, slow to fast Open Fast open slow close, slow to fast Open Fast close slow open, slow to fast Open Random strobe effect, slow to fast Open
9	000-255	<b>Red1</b> 0%→100%
10	000-255	<b>Green1</b> 0%→100%
11	000-255	<b>Blue1</b> 0%→100%
12	000-255	<b>White1</b> 0%→100%
13	000-255	<b>Red2</b> 0%→100%
14	000-255	<b>Green2</b> 0%→100%
15	000-255	<b>Blue2</b> 0%→100%
16	000-255	<b>White2</b> 0%→100%
17	000-255	<b>Red3</b> 00%→100%

18	000-255	<b>Green3</b> 0%→100%
19	000-255	<b>Blue3</b> 0%→100%
20	000-255	<b>White3</b> 0%→100%
21	000-255	<b>Red4</b> 0%→100%
22	000-255	<b>Green4</b> 0%→100%
23	000-255	<b>Blue4</b> 0%→100%
24	000-255	<b>White4</b> 0%→100%
25	000-255	<b>Red5</b> 0%→100%
26	000-255	<b>Green5</b> 0%→100%
27	000-255	<b>Blue5</b> 0%→100%
28	000-255	<b>White5</b> 0%→100%
29	000-255	<b>Red6</b> 0%→100%
30	000-255	<b>Green6</b> 0%→100%
31	000-255	<b>Blue6</b> 0%→100%
32	000-255	<b>White6</b> 0%→100%
33	000-255	<b>Red7</b> 0%→100%
34	000-255	<b>Green7</b> 0%→100%
35	000-255	<b>Blue7</b> 0%→100%
36	000-255	<b>White7</b> 0%→100%
37	000-079 080-089 090-099 100-139 140-149	<b>Function</b> Null Dimmer Smooth Dimmer Fast Null Pan/Tilt Reset

	150-159 160-199 200-209 210-255	Zoom Reset Null Reset All Null
--	--	---

The display effect of each pattern in 15th channel of channel 17 is as follows:

 Value: 0-3	 Value: 4-7	 Value: 8-11	 Value: 12-15	 Value: 16-19	 Value: 20-23	 Value: 24-27	 Value: 28-31
 Value: 32-35	 Value: 36-39	 Value: 40-43	 Value: 44-47	 Value: 48-51	 Value: 52-55	 Value: 56-59	 Value: 60-63
 Value: 64-67	 Value: 68-71	 Value: 72-75	 Value: 76-79	 Value: 80-83	 Value: 84-87	 Value: 88-91	 Value: 92-95
 Value: 96-99	 Value: 100-103	 Value: 104-107	 Value: 108-111	 Value: 112-115	 Value: 116-119	 Value: 120-123	 Value: 124-127
 Value: 128-131	 Value: 132-135	 Value: 136-139	 Value: 140-143	 Value: 144-147	 Value: 148-151	 Value: 152-155	 Value: 156-159
 Value: 160-163	 Value: 164-167	 Value: 168-171	 Value: 172-175	 Value: 176-179	 Value: 180-183	 Value: 184-187	 Value: 188-191
 Value: 192-195	 Value: 196-199	 Value: 200-203	 Value: 204-207	 Value: 208-211	 Value: 212-215	 Value: 216-219	 Value: 220-223
 Value: 224-227	 Value: 228-231	 Value: 232-235	 Value: 236-239	 Value: 240-243	 Value: 244-247	 Value: 248-251	 Value: 252-255

## **5. Error Information**

### **1. Pan Reset Error**

Check if the position of the pan mounting magnetic steel falls off or is damaged.

Check if there are other interference items in the pan operating range.

Check if the pan Hall elements is damaged.

Check if the pan Hall elements is in poor contact with the lead of the PCB board or disconnected.

Check if the pan motor is damaged.

Check if there is any damage to the circuit of the pan motor drive board.

### **2. Pan Encoder Error**

Check if the pan encoder is damaged.

Check if the pan encoder is in poor contact with the lead of the PCB board or disconnected.

### **3. Tilt Reset Error**

Check if the position of the tilt mounting magnetic steel falls off or is damaged.

Check if there are other interference items in the tilt operating range.

Check if the tilt Hall elements is damaged.

Check if the tilt Hall elements is in poor contact with the lead of the PCB board or disconnected.

Check if the tilt motor is damaged.

Check if there is any damage to the circuit of the tilt motor drive board.

### **4. Tilt Encoder Error**

Check if the tilt encoder is damaged.

Check if the tilt encoder is in poor contact with the lead of the PCB board or disconnected.

### **5. CPU-B/C/D Error**

Check whether the 485 (DATA) leads on the PCB board are install in place or disconnected.

Check whether the 485 (DATA) lead is disconnected.

Check whether the relevant signal circuit 485 (DATA) on the PCB board is damaged.

### **6. BaseFan/HeadFan cannot start**

Check if basefan/headfan is not running

### **7. BaseFan/HeadFan cannot stop**

Check if the basefan/headfan is still running when the temperature drops to the set value.

### **8. BaseFan/HeadFan speed too fast**

Check if the basefan/headfan is out of order.

### **9. BaseFan/HeadFan speed too slow**

Check if the basefan/headfan is out of order.

### **10. ArmFan cannot start**

Check if armfan is not running

### **11. ArmFan cannot stop**

Check if the armfan is still running when the temperature drops to the set value.

### **12. Zoom Reset Error**

Check if the position of the zoom mounting magnetic steel falls off or is damaged.

Check if there are other interference items in the zoom operating range.

Check if the zoom Hall elements is damaged.

Check if the zoom Hall elements is in poor contact with the lead of the PCB board or disconnected.

Check if the zoom motor is damaged.

Check if there is any damage to the circuit of the zoom motor drive board.

### **13. Led Temp. Too High**

Check if the fan is working properly.

Check if the fan speed is normal.

Check if the ambient temperature is abnormal.

## **6. Troubleshooting**

**Following are a few common problems that may occur during operation. Here are some suggestions for easy troubleshooting:**

### **A. The unit does not work, no light and the fan does not work**

1. Check the connect power.
2. Measure the mains voltage on the main connector.
3. Check the power on LED to see if it can be light up or not.

### **B. Not responding to DMX controller**

1. DMX LED should be on. If not, check DMX connectors, cables to see if they are linked properly.
2. If the DMX LED is on and no response to the channel, check the address settings and DMX polarity.
3. If you have intermittent DMX signal problems, check the pins on connectors or on PCB of the unit or the previous one.

4. Try to use another DMX controller.
5. Check to see if the DMX cables run near or run alongside to high voltage cables that may cause damage or interference to DMX interface circuit.

### **C. One of the channels is not working well**

1. The stepper motor might be damaged or the cable connected to the PCB is broken.
2. The motor's drive IC on the PCB might be out of condition.

## **7. Fixture Cleaning**

The cleaning of internal and external optical lenses and/or mirrors must be carried out periodically to optimize light output. Cleaning frequency depends on the environment in which the fixture operates: damp, smoky or particularly dirty surrounding can cause greater accumulation of dirt on the unit's optics.

- Clean with soft cloth and use normal glass to clean liquid.
- Always dry the parts carefully.
- Clean the external optics at least every 20 days. Clean the internal optics at least every 30 days.

**Innovation, Quality, Performance**