

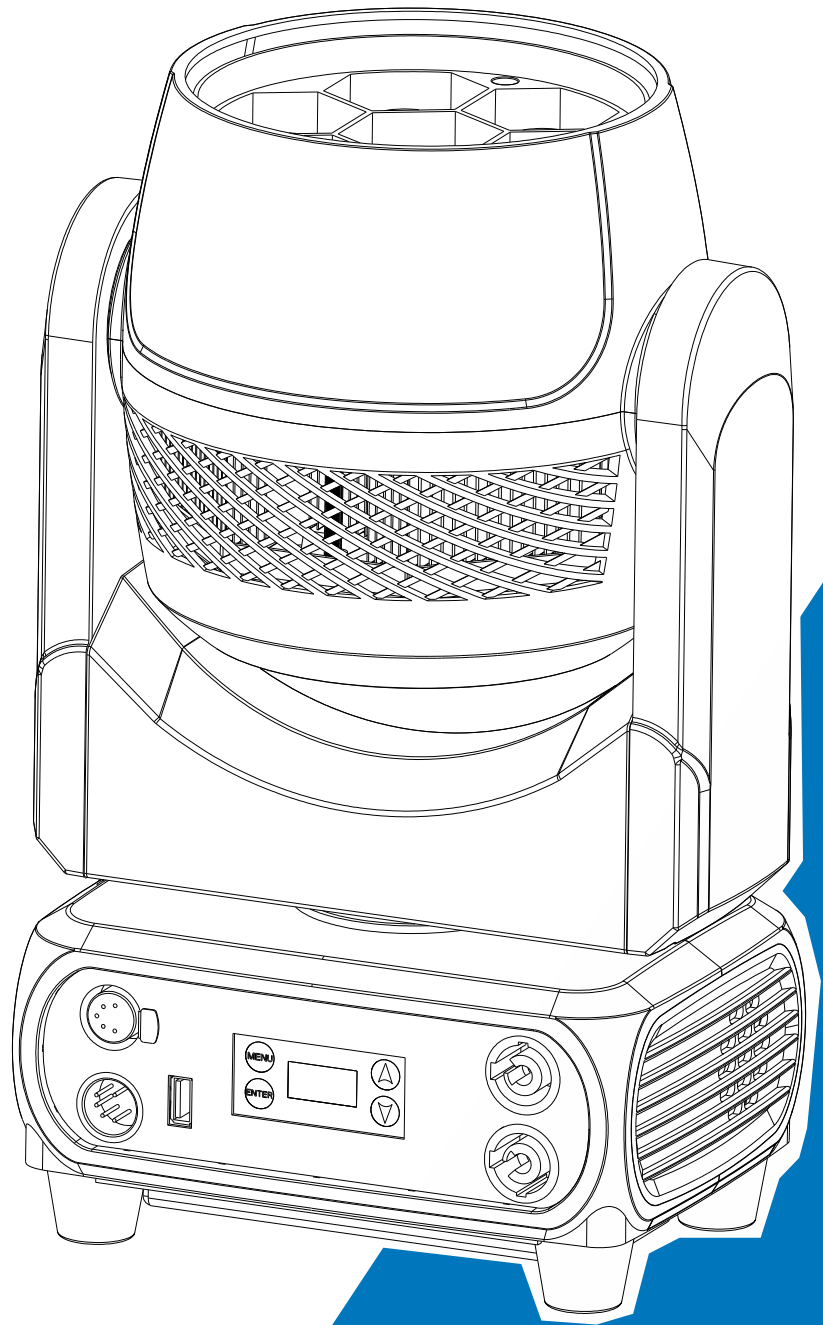

O₂xygen



Intertek
5000057

User Manual

Please read the instruction carefully before use

CONTENTS

01/ Safety Instructions.....	2
02/ Technical Specifications	6
03/ Control Panel.....	8
04/ Fixture Installation.....	9
05/ How To Set The Unit.....	11
5.1 Main Functions	11
5.2 Home Position Adjustment	25
06/ Control By Universal DMX Controller.....	29
6.1 DMX512 Connection.....	29
6.2 Address Setting.....	30
6.3 DMX512 Configuration	30
07/ Error Information	39
08/ Troubleshooting	43
09/ Fixture Cleaning.....	44

01/ Safety Instructions



Please read the instruction carefully which includes important information about the installation, usage and maintenance.

WARNING

Please keep this User Guide for future consultation. If you sell the unit to another user, be sure that they also receive this instruction manual.

Important:

Damages caused by the disregard of this user manual are not subject to warranty. The dealer will not accept liability for any resulting defects or problems.

- Unpack and check carefully to ensure that there is no transportation damage before using the unit.
- This product is for indoor use only. Use only in a dry location.
- DO install and operate by qualified operator.
- DO NOT allow children to operate the fixture.
- Use safety chain when fixing the unit. Handle the unit by carrying its base instead of head only.
- The unit must be installed in a location with adequate ventilation, at least 50cm from adjacent surfaces.
- Be sure that no ventilation slots is blocked, otherwise the unit will be overheated.
- Before operation, ensure that you are connecting this product to the proper voltage in accordance with the specifications in this manual or on the product's specification label.
- It's important to ground the yellow/green conductor to earth in order to avoid electric shock.
- Minimum ambient temperature TA: 0°C. Maximum ambient temperature TA: 40°C. Do not operate this product at a lower or higher temperature.
- DO NOT connect the device to any dimmer pack.
- Keep flammable materials away from the fixture while operating to avoid fire hazard.
- Make sure the power cord is not crimped or damaged; replace it immediately if damaged.
- Unit's surface temperature may reach up to 75°C. DO NOT touch the housing bare-handed during its operation.
- Avoid any flammable liquids, water or metal from entering the unit. Once it happens, cut

off the mains power immediately.

- DO NOT operate in a dirty or dusty environment. DO clean the fixture regularly.
- DO NOT touch any wire during operation as there might be a hazard of electric shock.
- Avoid entanglement of the power cord with other wires.
- The minimum distance to objects/surface must be more than 0.5 meters.
- In the event of serious operating problem, stop using the unit immediately.
- Never turn on and off the unit time after time.
- The housing, the lenses, or the ultraviolet filter must be replaced if they are visibly damaged.
- DO NOT open the housing as there are no user serviceable parts inside.
- DO NOT attempt to operate this unit if it becomes damaged. DO NOT attempt any repairs yourself. Repairs carried out by unskilled people can lead to damage or malfunction. Please contact the nearest authorized technical assistance center if needed.
- Disconnect this product from its power source before servicing.
- DO use the original packaging if the device is to be transported.
- Avoid direct eye exposure to the light source while the product is on.
- DO NOT operate this product if you see damage on the housing, shields, or cables. Have the damaged parts replaced by an authorized technician at once.

01/ Consignes de sécurité



Veillez lire attentivement les instructions qui contiennent des informations importantes sur l'installation, l'utilisation et l'entretien.

ATTENTION

Veillez conserver ce guide de l'utilisateur pour une consultation future. Si vous vendez l'appareil à un autre utilisateur, assurez-vous qu'il reçoive également ce manuel d'instructions.

Important:

Les dommages causés par le non-respect de ce manuel d'utilisation ne sont pas couverts par la garantie. Le revendeur n'acceptera aucune responsabilité pour les défauts ou problèmes qui en résultent.

- Déballez et vérifiez soigneusement qu'il n'y a pas de dommages dus au transport avant d'utiliser l'appareil.
- Ce produit est destiné à un usage intérieur uniquement. Il doit donc être utilisé uniquement dans un endroit sec.
- L'installation et la mise en fonctionnement doit être effectué par un opérateur qualifié.
- NE PAS permettre aux enfants d'utiliser l'appareil.
- Utilisez une chaîne de sécurité lors de la fixation de l'unité. Manipulez l'appareil en portant sa base au lieu de la tête uniquement.
- L'unité doit être installée dans un endroit avec une ventilation adéquate, à au moins 50cm des surfaces adjacentes.
- Assurez-vous qu'aucune fente d'aération du luminaire n'est obstruée, sinon il risque de surchauffer.
- Avant toute utilisation, assurez-vous que vous connectez ce luminaire à la tension appropriée conformément aux spécifications que vous trouverez dans ce manuel ou sur l'étiquette des spécifications collée sur la base du luminaire.
- Il est important de relier le file jaune/vert à la terre afin d'éviter tout choc électrique.
- Température ambiante minimale TA: 0°C. Température ambiante maximale TA: 40°C. N'utilisez pas ce luminaire à des températures inférieures ou supérieures.
- NE PAS connecter le luminaire à un pack de gradateurs.
- Gardez les matériaux inflammables à l'écart du luminaire pendant le fonctionnement

pour éviter tout risque d'incendie.

- Assurez-vous que le cordon d'alimentation n'est pas pincé ou endommagé; remplacez-le immédiatement s'il est endommagé.
- La température de surface de l'unité peut atteindre 75°C. NE PAS toucher les capots à mains nues pendant son fonctionnement.
- Évitez que des liquides inflammables, de l'eau ou du métal ne pénètrent dans l'appareil. Si cela se produit, coupez immédiatement l'alimentation secteur.
- NE PAS utiliser le luminaire dans un environnement sale ou poussiéreux. Cette appareil doit être nettoyer régulièrement.
- NE touchez AUCUN file pendant le fonctionnement car il pourrait y avoir un risque de choc électrique.
- Évitez l'enchevêtrement du cordon d'alimentation avec d'autres fils.
- La distance minimale de projection sur des objets ou sur des surfaces doit être supérieure à 0.5 mètres.
- En cas de problème de fonctionnement grave, arrêtez immédiatement d'utiliser l'appareil.
- N'allumez et n'éteignez jamais ce luminaire à maintes reprises.
- Le boîtier, les lentilles ou le filtre ultraviolet doivent être remplacés s'ils sont visiblement endommagés.
- NE PAS ouvrir le boîtier car il ne contient aucune pièce réparable par l'utilisateur.
- NE PAS mettre ce luminaire en fonctionnement s'il est endommagé. N'effectuez pas de réparations vous-même. Les réparations ne doivent être effectuées par des personnes non qualifiées, cela peut entraîner des dommages ou des dysfonctionnements. Veuillez contacter le centre d'assistance technique agréé le plus proche si nécessaire.
- Débranchez ce produit du secteur avant de procéder à l'entretien.
- Utiliser l'emballage d'origine si l'appareil doit être transporté.
- Évitez une exposition directe des yeux à la source lumineuse lorsque le produit est allumé.
- N'utilisez PAS ce produit si vous constatez des dommages sur le boîtier, les blindages ou les câbles. Faites remplacer immédiatement les pièces endommagées par un technicien agréé.

02/ Technical Specifications

Power Voltage	100-240V~ 50/60Hz		
Power Consumption	340W		
Light Source	7x40W RGBW LED		
Color Temperature	2500K-8000K		
Beam Angle	4.5°-36.5°		
Field Angle	8.5°-56.5°		
Dimmer/Strobe	0-100% smooth dimming; outstanding strobe effect with variable speed		
Movement	Pan	540°	
	Tilt	230°	
	Pan/Tilt Resolution	16 bit	
	Automatic pan/tilt position correction		
Control	DMX Channel	17/37 Channels	
	Control Mode	DMX512	
		RDM	
		Primary/Secondary Mode	
Firmware Upgrade	via DMX link or USB disk		
Construction	Display	OLED display	
	Data In/Out	5-pin XLR (3-pin XLR is optional)	
	Power In/Out	Power Connector in/out	
	Protection Rating	IP20	
<p><i>Description for power cord set should be used: Listed SJT flexible cord with rating: 300V, 105°C, 16AWG x 3C, molded with 5-15P attachment plug and terminated with cord connector model SAC3FCA with rating 250V, 20A by NINGBO HAISHU DISTRICT SEETRONIC ELECTRONIC CO., LTD. The power cord shall be at least 914mm (It is to be measured from the face of attachment plug to the face of connector).</i></p>			
Features	Pixel control, uniform RGBW color mixing and rainbow effect		
	Motorized liner zoom system		
	Compact design, small size, fast and silent operation		
	Automated color calibration system to ensure a consistent output		
Dimensions	216x170x345mm	8.5"x6.7"x13.6" in	
Weight	6.3kgs	14lbs	

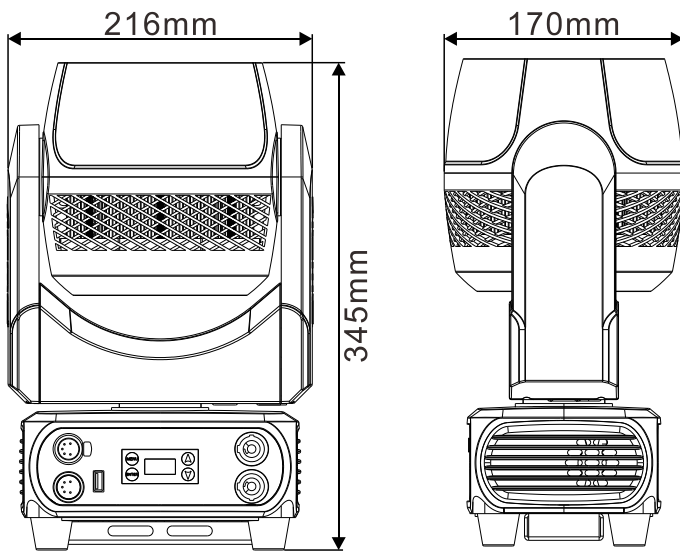

Photometric Diagram:

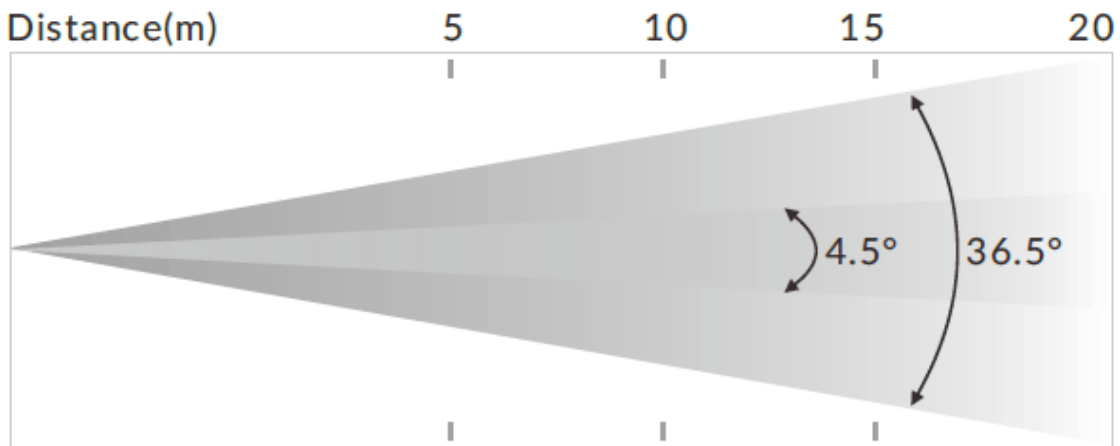

Distance(m)	5	10	15	20
4.5° Lux	13,300	3,325	1,478	831
Diameter(m)	0.7	1.4	2.1	2.8
36.5° Lux	661	165	73	41
Diameter(m)	5.4	10.8	16.2	21.6

03/ Control Panel

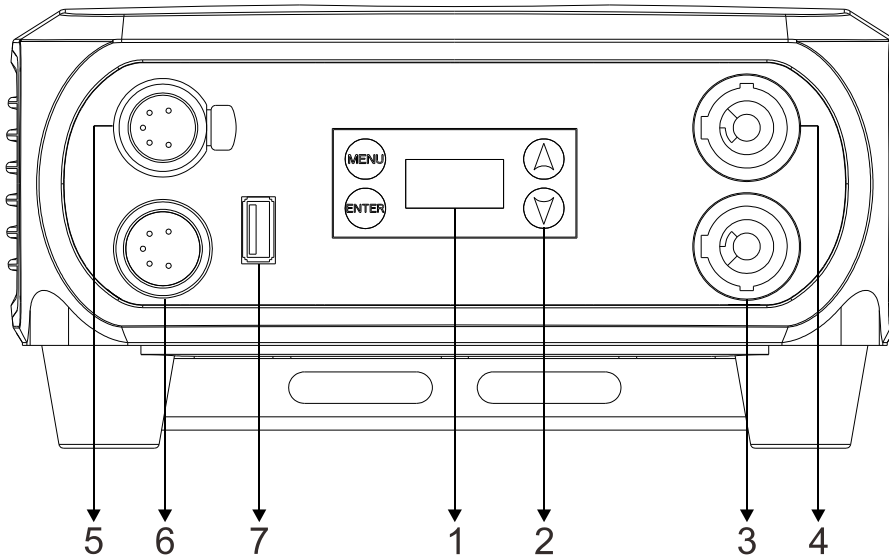

1. Display	To show the various menus and the selected function	
2. Buttons	MENU	To enter into move backward or leave the menu
	▲ UP	To go backward to move up in the menu
	▼ DOWN	To go forward to move down in the menu
	ENTER	To perform the desired functions
3. POWER IN	To connect to supply power	
4. POWER OUT	To connect to the next fixture	
5. DMX OUT	For DMX512 link, use 5-pin XLR cable to link the next units to output DMX signal (3-pin XLR cable is optional)	
6. DMX IN	For DMX512 link, use 5-pin XLR cable to link the unit and DMX controller to input DMX signal (3-pin XLR cable is optional)	
7. FIRMWARE UPGRADE	Used to upgrade fixture's firmware	

04/ Fixture Installation

- ▶ DO install and operate by qualified operator. Fixture(s) should be installed in areas outside walking paths, seating areas, or away from areas where unauthorized personnel might reach the fixture by hand. NEVER stand directly below the fixture(s) when rigging, removing or servicing.
- ▶ Always ensure that the unit is firmly fixed to avoid vibration and slipping off during operation. Ensure that the trussing or area of installation must be able to hold 10 times the weight without any deformation. Always attach a safety cable that can hold at least 12 times the weight of the fixture whenever installing this fixture in a suspended environment to ensure that the fixture will not fall if the clamp fails.
- ▶ This fixture is fully operational in three different mounting positions: hanging upside-down, mounted sideways on trussing, or set on a flat level surface. Always use and install the supplied safety cable as a safety measure to prevent accidental damage and/or injury in the event the clamp fails.

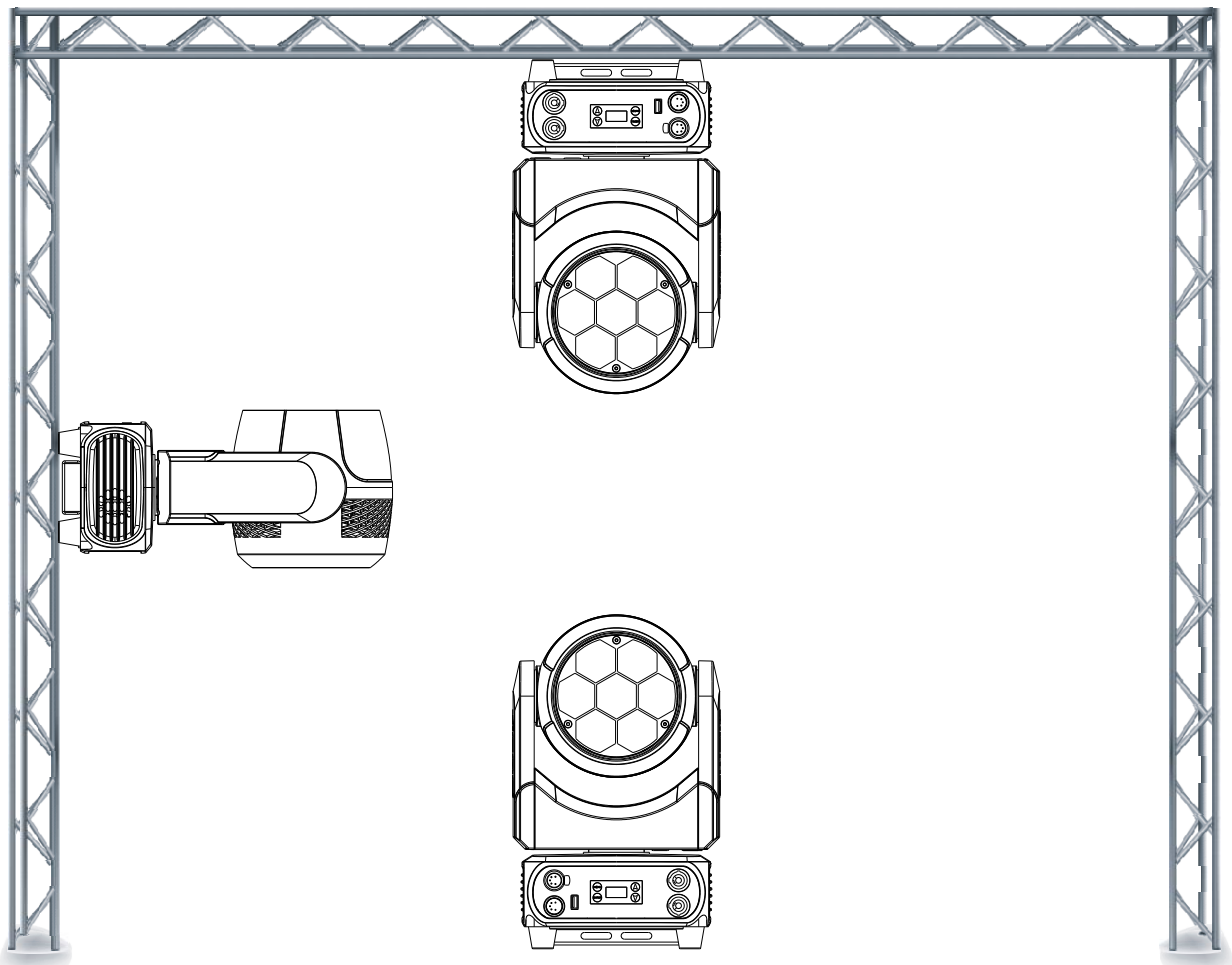

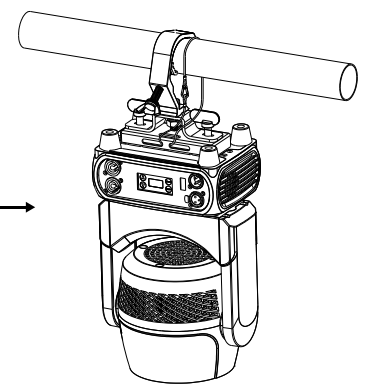
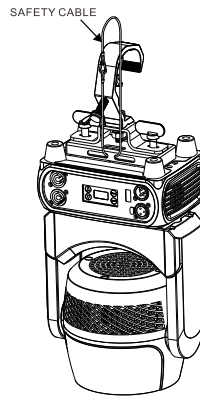
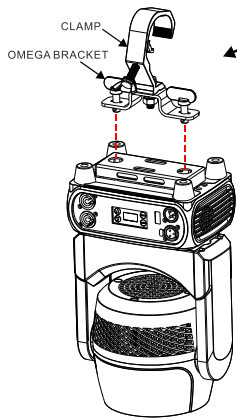
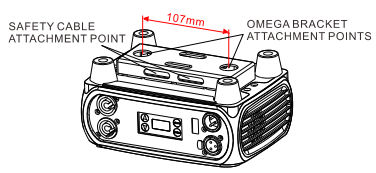
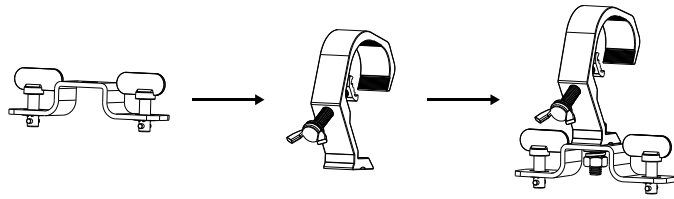

05/ How To Set The Unit

5.1 Main Functions

- ▶ To access the control menus, press the [MENU] button.
- ▶ Navigate the menu structure, using the [ENTER], [▲ UP] and [▼ DOWN] buttons.
- ▶ To select a menu option or to confirm a selection, press the [ENTER] button.
- ▶ To return to a higher level in the menu structure without making a change, press the [MENU] button, or wait 30 seconds.

The main functions are shown below:

MENU	SUBMENU	OPTIONS		
DMX Settings	DMX Address	1-496 (17 CH)	(Default=1)	
		1-476 (37 CH)		
	Channel Mode	Mode 1 (17)		
		Mode 2 (37)		
	No DMX Status	Blackout		
		Hold		
		Manual		
Pri. Sec.				
View DMX Value				
Fixture Settings	Pan Invert	No		
		Yes		
	Tilt Invert	No		
		Yes		
	P/T Feedback	No		
		Yes		
	Zoom Invert	No		
		Yes		
	Fan Mode	Auto		
		Silent		
	Dimmer Curve	Linear		
		Square Law		
		Inv SQ Law		
		S Curve		
Dimmer Speed	Fast			
	Smooth			

MENU	SUBMENU	OPTIONS		
	White Balance	Red	125-255	
		Green	125-255	
		Blue	125-255	
		Red 1	125-255	
		Green 1	125-255	
		Blue 1	125-255	
		
		Red 7	125-255	
		Green 7	125-255	
		Blue 7	125-255	
	Color Calibration	Off		
		On		
	Calibration Mode	High CRI		
		High Output		
Pri/Sec Mode	Secondary			
	Primary			
Display Settings	Display Invert	No		
		Yes		
	Temperature Unit	°C		
		°F		
	Display Warning	Off		
		On		
	Language	English		
		Chinese		
Auto Test				
Manual Test	Mode 1		Mode 2	
	Clear	No/Yes	Clear	No/Yes
	Pan	0-255	Pan	0-255
	Tilt	0-255	Tilt	0-255
	Zoom	0-255	Zoom	0-255
	Dimmer	0-255	Dimmer	0-255
	Shutter	0-255	Shutter	0-255
	Red	0-255	Red 1	0-255
	Green	0-255	Green 1	0-255
	Blue	0-255	Blue 1	0-255
	White	0-255	White 1	0-255
	CTO	0-255
Color Macro	0-255	Red 7	0-255	

MENU	SUBMENU	OPTIONS			
	Pixel	0-255	Green 7	0-255	
	Pixel Rotating	0-255	Blue 7	0-255	
			White 7	0-255	
Show Program	Set Scene Totals	0-50			
	Edit Scene Color	1-50	Red	0-255	
			Green	0-255	
			Blue	0-255	
			White	0-255	
	Fade Time	0-255			
	Hold Time	0-255			
	Pan POS	0-255			
Tilt POS	0-255				
Zoom POS	0-255				
Information	Fixture Use Hour				
	LED Use Hour	Total LED Hour			
		LED On Hour			
		LED Hours Reset	No		
	Temperature		Yes	Password=050	
			Current	Max temp	
	Fan State	LED's			
		Head			
		Base			
	Upgrade File				
	Firmware Version				
RDM UID					
Error Logs	Fixture Errors				
	Reset Error Log	No			
		Yes	Password=050		
Reset Functions	Pan/Tilt Reset	No			
		Yes			
	Effect Reset	No			
		Yes			
	All Reset	No			
		Yes			
Factory Restore	No				
	Yes				

DMX Settings

Enter the control menu and select **DMX Settings**, press ENTER. Use the UP/DOWN button to select **DMX Address**, **Channel Mode**, **No DMX Status** or **View DMX Value**.

DMX Address

Select **DMX Address**, press ENTER.

Use UP/DOWN button to select an address, confirm your selection with ENTER.

CHANNEL MODE	DMX ADDRESS
Mode 1 (17)	1-496
Mode 2 (37)	1-476

To exit the menu, press MENU, or wait 30 seconds.

Channel Mode

Select **Channel Mode**, press ENTER.

Use UP/DOWN button to select between **Mode 1 (17)** and **Mode 2 (37)**, confirm your selection with ENTER.

To exit the menu, press MENU, or wait 30 seconds.

No DMX Status

Select **No DMX Status**, press ENTER.

Use UP/DOWN button to select one of the following status:

Blackout (Fixture blacks out if DMX signal stops)

Hold (The device continues to operate in the current mode with the last active DMX values until the signal returns)

Manual (The device accepts the DMX value stored in the 'Manual Test' menu)

Pri. Sec. (Primary/Secondary Mode)

Confirm your selection with ENTER.

To exit the menu, press MENU, or wait 30 seconds.

View DMX Value

Select **View DMX Value**, press ENTER.

Use UP/DOWN button to select the desired DMX channel, for which the value is to be displayed.

To exit the menu, press MENU, or wait 30 seconds.

Fixture Settings

Enter the control menu and select **Fixture Settings**, press ENTER. Use the UP/DOWN button to select **Pan Invert**, **Tilt Invert**, **P/T Feedback**, **Zoom Invert**, **Fan Mode**, **Dimmer Curve**, **Dimmer Speed**, **White Balance**, **Color Calibration**, **Calibration Mode** or **Pri/Sec Mode**.

Pan Invert

Select **Pan Invert**, press ENTER.

Use UP/DOWN button to select **No** (pan invert deactivated) or **Yes** (pan invert activated), confirm your selection with ENTER.

To exit the menu, press MENU, or wait 30 seconds.

Tilt Invert

Select **Tilt Invert**, press ENTER.

Use UP/DOWN button to select **No** (tilt invert deactivated) or **Yes** (tilt invert activated), confirm your selection with ENTER.

To exit the menu, press MENU, or wait 30 seconds.

P/T Feedback

Select **P/T Feedback**, press ENTER.

Use UP/DOWN button to select **No** (pan/tilt feedback deactivated) or **Yes** (pan/tilt feedback activated), confirm your selection with ENTER.

To exit the menu, press MENU, or wait 30 seconds.

Zoom Invert

Select **Zoom Invert**, press ENTER.

Use UP/DOWN button to select **No** (zoom invert deactivated) or **Yes** (zoom invert activated), confirm your selection with ENTER.

To exit the menu, press MENU, or wait 30 seconds.

Fan Mode

Select **Fan Mode**, press ENTER.

Use UP/DOWN button to select **Auto** or **Silent**, confirm your selection with ENTER.

To exit the menu, press MENU, or wait 30 seconds.

Dimmer Curve

Select **Dimmer Curve**, press ENTER.

Use UP/DOWN button to select **Linear**, **Square Law**, **Inv SQ Law** or **S Curve**, confirm your selection with ENTER.

Dimmer Modes

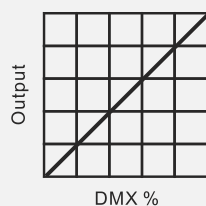

Optically Linear

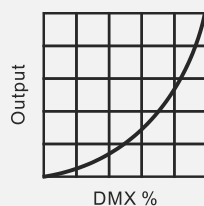

Square Law

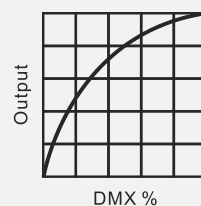

Inverse Square Law

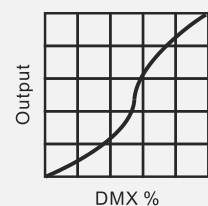

S-curve

To exit the menu, press MENU, or wait 30 seconds.

Dimmer Speed

Select **Dimmer Speed**, press ENTER.

Use UP/DOWN button to select **Fast** or **Smooth**, confirm your selection with ENTER.

To exit the menu, press MENU, or wait 30 seconds.

White Balance

Select **White Balance**, press ENTER.

Use UP/DOWN button to select **Red, Green, Blue, Red 1, Green 1, Blue 1** or **Red 7, Green 7, Blue 7**, confirm your selection with ENTER.

Use UP/DOWN button to select a value between **125** and **255**, confirm your selection with ENTER.

To exit the menu, press MENU, or wait 30 seconds.

Color Calibration

Select **Color Calibration**, press ENTER.

Use UP/DOWN button to select **Off** or **On**, confirm your selection with ENTER.

To exit the menu, press MENU, or wait 30 seconds.

Calibration Mode

Select **Calibration Mode**, press ENTER.

Use UP/DOWN button to select **High CRI** or **High Output**, confirm your selection with ENTER.

To exit the menu, press MENU, or wait 30 seconds.

Pri/Sec Mode

Select **Pri/Sec Mode**, press ENTER.

Use UP/DOWN button to select **Secondary** or **Primary**, confirm your selection with ENTER.

To exit the menu, press MENU, or wait 30 seconds.

Display Settings

Enter the control menu and select **Display Settings**, press ENTER. Use the UP/DOWN button to select **Display Invert**, **Temperature Unit**, **Display Warning** or **Language**.

Display Invert

Select **Display Invert**, press ENTER.

Use UP/DOWN button to select **No** (display normal) or **Yes** (display inverted), confirm your selection with ENTER.

To exit the menu, press MENU, or wait 30 seconds.

Temperature Unit

Select **Temperature Unit**, press ENTER.

Use UP/DOWN button to select **°C** or **°F**, confirm your selection with ENTER.

To exit the menu, press MENU, or wait 30 seconds.

Display Warning

Select **Display Warning**, press ENTER.

Use UP/DOWN button to select **Off** or **On**, confirm your selection with ENTER.

To exit the menu, press MENU, or wait 30 seconds.

Language

Select **Language**, press ENTER.

Use UP/DOWN button to select **English** or **Chinese**, confirm your selection with ENTER.

To exit the menu, press MENU, or wait 30 seconds.

Auto Test

Select **Auto Test**, press ENTER.

The device immediately performs an automatic self-test.

To end the automatic self-test and exit the menu, press MENU, or wait 30 seconds.

Manual Test

Select **Manual Test**, press ENTER.

Use UP/DOWN button to select the channel for which the manual test is to be performed, confirm your selection with ENTER.

Use UP/DOWN button to select a value, confirm your selection with ENTER.

To exit the menu, press MENU, or wait 30 seconds.

(The device returns to its original DMX state after the manual test. The test values are saved automatically when the device is switched off.)

Show Program

Enter the control menu and select **Show Program**, press ENTER. Use the UP/DOWN button to select **Set Scene Totals**, **Edit Scene Color**, **Fade Time**, **Hold Time**, **Pan POS**, **Tilt POS** or **Zoom POS**.

Set Scene Totals

Select **Set Scene Totals**, press ENTER.

Use UP/DOWN button to select a value between **0** and **50**, confirm your selection with ENTER.

To exit the menu, press MENU, or wait 30 seconds.

Edit Scene Color

Select **Edit Scene Color**, press ENTER.

Use UP/DOWN button to select a value between **1** and **50**, confirm your selection with ENTER.

Use UP/DOWN button to select **Red**, **Green**, **Blue** or **White**, confirm your selection with ENTER.

Use UP/DOWN button to select a value between **0** and **255**, confirm your selection with ENTER.

To exit the menu, press MENU, or wait 30 seconds.

Fade Time

Select **Fade Time**, press ENTER.

Use UP/DOWN button to select a value between **0** and **255**, confirm your selection with ENTER.

To exit the menu, press MENU, or wait 30 seconds.

Hold Time

Select **Hold Time**, press ENTER.

Use UP/DOWN button to select a value between **0** and **255**, confirm your selection with ENTER.

To exit the menu, press MENU, or wait 30 seconds.

Pan POS

Select **Pan POS**, press ENTER.

Use UP/DOWN button to select a value between **0** and **255**, confirm your selection with ENTER.

To exit the menu, press MENU, or wait 30 seconds.

Tilt POS

Select **Tilt POS**, press ENTER.

Use UP/DOWN button to select a value between **0** and **255**, confirm your selection with ENTER.

To exit the menu, press MENU, or wait 30 seconds.

Zoom POS

Select **Zoom POS**, press ENTER.

Use UP/DOWN button to select a value between **0** and **255**, confirm your selection with ENTER.

To exit the menu, press MENU, or wait 30 seconds.

Information

Enter the control menu and select **Information**, press ENTER. Use the UP/DOWN button to select **Fixture Use Hour**, **LED Use Hour**, **Temperature**, **Fan State**, **Upgrade File**, **Firmware Version**, **RDM UID** or **Error Logs**.

Fixture Use Hour

Select **Fixture Use Hour**, press ENTER.
The operating hours is displayed.
To exit the menu, press MENU, or wait 30 seconds.

LED Use Hour

Select **LED Use Hour**, press ENTER.
Use UP/DOWN button to select **Total LED Hour** (total time) or **LED On Hour** (current switch-on time), confirm your selection with ENTER.
The total time or current switch-on time is displayed.
Use UP/DOWN button to select **LED Hours Reset**, confirm your selection with ENTER.
If you wish to reset the LED operating hours, select **Yes**. If you do not wish to reset anything, select **No**. Confirm your selection with ENTER.
If you select **Yes**, use UP/DOWN button to set the password 050, confirm your selection with ENTER. The LED operating hours is reset.
To exit the menu, press MENU, or wait 30 seconds.

Temperature

Select **Temperature**, press ENTER.
The device temperature is displayed.
To exit the menu, press MENU, or wait 30 seconds.

Fan State

Select **Fan State**, press ENTER.
The fan status is displayed.
To exit the menu, press MENU, or wait 30 seconds.

Upgrade File

Select **Upgrade File**, press ENTER.

The upgrade file is displayed.

To exit the menu, press MENU, or wait 30 seconds.

Firmware Version

Select **Firmware Version**, press ENTER.

The firmware version is displayed.

To exit the menu, press MENU, or wait 30 seconds.

RDM UID

Select **RDM UID**, press ENTER.

The RDM UID is displayed.

To exit the menu, press MENU, or wait 30 seconds.

Error Logs

Select **Error Logs**, press ENTER.

Use UP/DOWN button to select **Fixture Errors**, confirm your selection with ENTER.

The error list is displayed.

Use UP/DOWN button to select **Reset Error Log**, confirm your selection with ENTER.

If you wish to reset the relevant error logs, select **Yes**. If you do not wish to reset anything, select **No**. Confirm your selection with ENTER.

If you select **Yes**, use UP/DOWN button to set the password 050, confirm your selection with ENTER. The relevant error logs are reset.

To exit the menu, press MENU, or wait 30 seconds.

Reset Functions

Enter the control menu and select **Reset Functions**, press ENTER. Use the UP/DOWN button to select **Pan/Tilt Reset**, **Effect Reset** or **All Reset**.

Pan/Tilt Reset

Select **Pan/Tilt Reset**, press ENTER.

Use UP/DOWN button to select **No** or **Yes** (the device will run built-in program to reset pan/tilt to their home positions), confirm your selection with ENTER.

To exit the menu, press MENU, or wait 30 seconds.

Effect Reset

Select **Effect Reset**, press ENTER.

Use UP/DOWN button to select **No** or **Yes** (the device will run built-in program to reset effect to their home positions), confirm your selection with ENTER.

To exit the menu, press MENU, or wait 30 seconds.

All Reset

Select **All Reset**, press ENTER.

Use UP/DOWN button to select **No** or **Yes** (the device will run built-in program to reset all to their home positions), confirm your selection with ENTER.

To exit the menu, press MENU, or wait 30 seconds.

Factory Restore

Select **Factory Restore**, press ENTER.

If you wish to reset the device to the factory settings, select **Yes**. If you do not wish to reset anything, select **No**. Confirm your selection with ENTER.

To exit the menu, press MENU, or wait 30 seconds.

RDM functions: Certain menus of the device and functions can be called up via the RDM protocol.

The parameter IDs are implemented as follows for different commands:

Parameter ID	Command 'Discovery'	Command 'Set'	Command 'Get'
DISC_UNIQUE_BRANCH	✓		
DISC_MUTE	✓		
DISC_UN_MUTE	✓		
DEVICE_INFO			✓
SUPPORTED_PARAMETERS			✓
SOFTWARE_VERSION_LABEL			✓
DMX_START_ADDRESS		✓	✓
IDENTIFY_DEVICE		✓	✓
DEVICE_MODEL_DESCRIPTION			✓
PARAMETER_DESCRIPTION			✓
MANUFACTURER_LABEL			✓
DEVICE_LABEL		✓	✓
FACTORY_DEFAULTS		✓	✓
BOOT_SOFTWARE_VERSION_ID			✓
BOOT_SOFTWARE_VERSION_LABEL			✓
DMX_PERSONALITY		✓	✓
DMX_PERSONALITY_DESCRIPTION			✓
SLOT_INFO			✓
SLOT_DESCRIPTION			✓
SENSOR_DEFINITION			✓
SENSOR_VALUE			✓
DEVICE_HOURS			✓
PAN_INVERT		✓	✓
TILT_INVERT		✓	✓
RESET_DEVICE		✓	

✓ -Command implemented for the respective parameter ID

5.2 Home Position Adjustment

- ▶ To access the control menus, press the [MENU] button.
- ▶ To access the offset menus, long-press the [ENTER] button.
- ▶ Navigate the offset menus, using the [ENTER], [▲ UP] and [▼ DOWN] buttons.
- ▶ To select a menu option or to confirm a selection, press the [ENTER] button.
- ▶ To return to a higher level in the menu structure without making a change, press the [MENU] button, or wait 30 seconds.

OFFSET MENU	VALUES
Frequency(Hz)	1072~1327
Pan	-128~127
Tilt	-128~127
Zoom	-128~127
Red	0~1000
Green	0~1000
Blue	0~1000
White	0~1000
Red 1	0~1000
.....
Red 7	0~1000
Green 1	0~1000
.....
Green 7	0~1000
Blue 1	0~1000
.....
Blue 7	0~1000
White 1	0~1000
.....
White 7	0~1000

Frequency(Hz)

Select **Frequency(Hz)**, press ENTER.

Use UP/DOWN button to select a value between 1072 and 1327, confirm your selection with ENTER.

To exit the offset menu, press MENU, or wait 30 seconds.

Pan

Select **Pan**, press ENTER.

Use UP/DOWN button to select a value between -128 and 127, confirm your selection with ENTER.

To exit the offset menu, press MENU, or wait 30 seconds.

Tilt

Select **Tilt**, press ENTER.

Use UP/DOWN button to select a value between -128 and 127, confirm your selection with ENTER.

To exit the offset menu, press MENU, or wait 30 seconds.

Zoom

Select **Zoom**, press ENTER.

Use UP/DOWN button to select a value between -128 and 127, confirm your selection with ENTER.

To exit the offset menu, press MENU, or wait 30 seconds.

Red

Select **Red**, press ENTER.

Use UP/DOWN button to select a value between 0 and 1000, confirm your selection with ENTER.

To exit the offset menu, press MENU, or wait 30 seconds.

Green

Select **Green**, press ENTER.

Use UP/DOWN button to select a value between 0 and 1000, confirm your selection with ENTER.

To exit the offset menu, press MENU, or wait 30 seconds.

Blue

Select **Blue**, press ENTER.

Use UP/DOWN button to select a value between 0 and 1000, confirm your selection with ENTER.

To exit the offset menu, press MENU, or wait 30 seconds.

White

Select **White**, press ENTER.

Use UP/DOWN button to select a value between 0 and 1000, confirm your selection with ENTER.

To exit the offset menu, press MENU, or wait 30 seconds.

Red 1

Select **Red 1**, press ENTER.

Use UP/DOWN button to select a value between 0 and 1000, confirm your selection with ENTER.

To exit the offset menu, press MENU, or wait 30 seconds.

.....

Red 7

Select **Red 7**, press ENTER.

Use UP/DOWN button to select a value between 0 and 1000, confirm your selection with ENTER.

To exit the offset menu, press MENU, or wait 30 seconds.

Green 1

Select **Green 1**, press ENTER.

Use UP/DOWN button to select a value between 0 and 1000, confirm your selection with ENTER.

To exit the offset menu, press MENU, or wait 30 seconds.

.....

Green 7

Select **Green 7**, press ENTER.

Use UP/DOWN button to select a value between 0 and 1000, confirm your selection with ENTER.

To exit the offset menu, press MENU, or wait 30 seconds.

Blue 1

Select **Blue 1**, press ENTER.

Use UP/DOWN button to select a value between 0 and 1000, confirm your selection with ENTER.

To exit the offset menu, press MENU, or wait 30 seconds.

.....

Blue 7

Select **Blue 7**, press ENTER.

Use UP/DOWN button to select a value between 0 and 1000, confirm your selection with ENTER.

To exit the offset menu, press MENU, or wait 30 seconds.

White 1

Select **White 1**, press ENTER.

Use UP/DOWN button to select a value between 0 and 1000, confirm your selection with ENTER.

To exit the offset menu, press MENU, or wait 30 seconds.

.....

White 7

Select **White 7**, press ENTER.

Use UP/DOWN button to select a value between 0 and 1000, confirm your selection with ENTER.

To exit the offset menu, press MENU, or wait 30 seconds.

06/ Control By Universal DMX Controller

6.1 DMX512 Connection

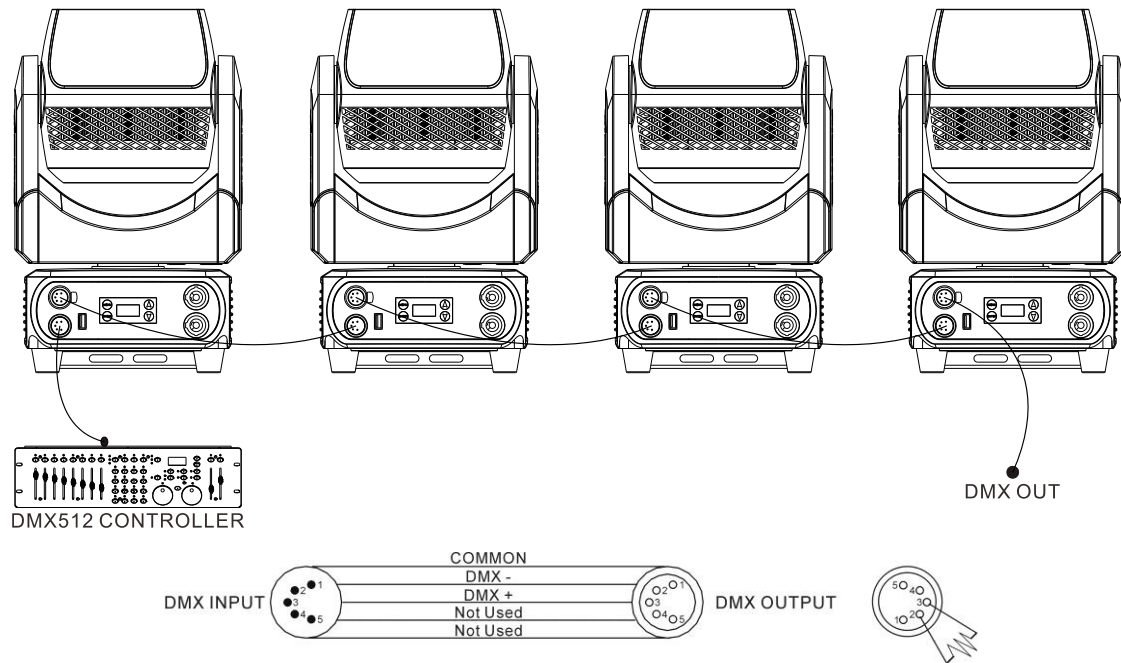

1. At last unit, the DMX cable has to be terminated with a terminator. Solder a 120-ohm 1/4W resistor between pin 2(DMX-) and pin 3(DMX+) into a 3-pin XLR-plug and plug it in the DMX-output of the last unit.
2. Connect the unit together in a “daisy chain” by XLR plug cable from the output of the unit to the input of the next unit. The cable can only be used in series and cannot be connected in parallel. DMX 512 is a very high-speed signal. Inadequate or damaged cables, soldered joints or corroded connectors can easily distort the signal and shut down the system.
3. The DMX output and input connectors are pass-through to maintain the DMX circuit, when one of the units’ power is disconnected.
4. Each lighting unit needs to have a DMX address to receive the data by the controller. The address number is between 1-512.
5. The end of the DMX 512 system should be terminated to reduce signal errors.
6. 3 pin XLR connectors are more popular than 5 pins XLR.
 - 3 pin XLR: Pin 1: GND, Pin 2: Negative signal (-), Pin 3: Positive signal (+)
 - 5 pin XLR: Pin 1: GND, Pin 2: Negative signal (-), Pin 3: Positive signal (+), Pin4, Pin5 not used.

6.2 Address Setting

If you use a universal DMX controller to control the units, you have to set DMX address between 1 and 512 so that the units can receive DMX signal.

Press the MENU button to access the control menus, select DMX Settings, press the ENTER button to confirm. Use the UP/DOWN button to select DMX Address, press the ENTER button to confirm, the present address will show on the display. Use the UP/DOWN button to adjust the address between 001 and 512, press the ENTER button to store. To exit the menu, press MENU, or wait 30 seconds.

Please refer to the following diagram to address your DMX512 channel for the first 4 units.

Channel Mode	Unit 1 Address	Unit 2 Address	Unit 3 Address	Unit 4 Address
17 channels	1	18	35	52
37 channels	1	38	75	112

6.3 DMX512 Configuration

Please control the fixture by referring to the configurations below.

Attentions:

- ▶ The unit will maintain the last condition until reset if you cut-off the DMX signal.
- ▶ For the channel Function, keep the value for about 3 seconds, then the corresponding function will take into effect.

17 Channels (Mode 1):

CHANNEL	VALUE	FUNCTION
1	000-255	PAN 0°→540°
2	000-255	PAN FINE
3	000-255	TILT 0°→230°
4	000-255	TILT FINE
5	000-255	ZOOM Wide→Narrow

6	000-255	DIMMER 0%→100%
7	000-255	DIMMER FINE
8	000-007 008-015 016-131 132-139 140-181 182-189 190-231 232-239 240-247 248-255	STROBE Close Open Strobe from Slow to Fast Open Fast Close Slow Open from Slow to Fast Open Fast Open Slow Close from Slow to Fast Open Random Strobe from Fast to Slow Open
9	000-255	RED 0%→100%
10	000-255	GREEN 0%→100%
11	000-255	BLUE 0%→100%
12	000-255	WHITE 0%→100%
13	000 001-004 005-009 010-013 014-018 019-022 023-027 028-031 032-036 037-040 041-045 046-049 050-054 055-058 059-063 064-067 068-072 073-076 077-081 082-085 086-090 091-094 095-099	CTO Null 8000K 7900K 7800K 7700K 7600K 7500K 7400K 7300K 7200K 7100K 7000K 6900K 6800K 6700K 6600K 6500K 6400K 6300K 6200K 6100K 6000K 5900K

	100-103	5800K
	104-108	5700K
	109-112	5600K
	113-117	5500K
	118-121	5400K
	122-126	5300K
	127-130	5200K
	131-135	5100K
	136-139	5000K
	140-144	4900K
	145-148	4800K
	149-153	4700K
	154-157	4600K
	158-162	4500K
	163-166	4400K
	167-171	4300K
	172-175	4200K
	176-180	4100K
	181-184	4000K
	185-189	3900K
	190-193	3800K
	194-198	3700K
	199-202	3600K
	203-207	3500K
	208-211	3400K
	212-216	3300K
	217-220	3200K
	221-225	3100K
	226-229	3000K
	230-234	2900K
	235-238	2800K
	239-243	2700K
	244-247	2600K
	248-255	2500K
		COLOR MACRO
	000-007	Null
	008-011	Color 1
	012-015	Color 2
	016-019	Color 3
	020-023	Color 4
	024-027	Color 5
	028-031	Color 6
	032-035	Color 7
	036-039	Color 8
	040-043	Color 9
	044-047	Color 10
	048-051	Color 11
14		

	052-055 056-059 060-063 064-067 068-071 072-075 076-079 080-083 084-087 088-091 092-095 096-099 100-103 104-107 108-111 112-115 116-119 120-123 124-127 128-131 132-135 136-165 166-195 196-205 206-215 216-225 226-235 236-245 246-255	Color 12 Color 13 Color 14 Color 15 Color 16 Color 17 Color 18 Color 19 Color 20 Color 21 Color 22 Color 23 Color 24 Color 25 Color 26 Color 27 Color 28 Color 29 Color 30 Color 31 Color 32 Clockwise Rotation, Fast to Slow Counter-Clockwise Rotation, Slow to Fast Red→Green Fast to Slow Red→Blue Fast to Slow Red→White Fast to Slow Green→Blue Fast to Slow Green→White Fast to Slow Blue→White Fast to Slow
15	000-003 004-007 008-011 012-015 016-019 020-023 024-027 028-031 032-035 036-039 040-043 044-047 048-051 052-055 056-059 060-063 064-067	PIXEL SELECT Open Pattern 1 Pattern 2 Pattern 3 Pattern 4 Pattern 5 Pattern 6 Pattern 7 Pattern 8 Pattern 9 Pattern 10 Pattern 11 Pattern 12 Pattern 13 Pattern 14 Pattern 15 Pattern 16

068-071	Pattern 17
072-075	Pattern 18
076-079	Pattern 19
080-083	Pattern 20
084-087	Pattern 21
088-091	Pattern 22
092-095	Pattern 23
096-099	Pattern 24
100-103	Pattern 25
104-107	Pattern 26
108-111	Pattern 27
112-115	Pattern 28
116-119	Pattern 29
120-123	Pattern 30
124-127	Pattern 31
128-131	Pattern 32
132-135	Pattern 33
136-139	Pattern 34
140-143	Pattern 35
144-147	Pattern 36
148-151	Pattern 37
152-155	Pattern 38
156-159	Pattern 39
160-163	Pattern 40
164-167	Pattern 41
168-171	Pattern 42
172-175	Pattern 43
176-179	Pattern 44
180-183	Pattern 45
184-187	Pattern 46
188-191	Pattern 47
192-195	Pattern 48
196-199	Pattern 49
200-203	Pattern 50
204-207	Pattern 51
208-211	Pattern 52
212-215	Pattern 53
216-219	Pattern 54
220-223	Pattern 55
224-227	Pattern 56
228-231	Pattern 57
232-235	Pattern 58
236-239	Pattern 59
240-243	Pattern 60
244-247	Random (Pattern 1-7)
248-251	Pattern 61
252-255	Open

16	000-031	PIXEL ROTATION Null Clockwise Rotation, Fast to Slow Null Counter-Clockwise Rotation, Slow to Fast Null
	032-091	
	092-101	
	102-161	
	162-255	
17	000-029	FUNCTION Null Dimmer Curve: Linear Dimmer Curve: Square Law Dimmer Curve: Inverse Square Law Dimmer Curve: S Curve Null Dimmer Speed: Smooth Dimmer Speed: Fast Null Zoom Invert Enable Zoom Invert Disable Pan/Tilt Reset Effect Reset Color Calibration: On Color Calibration: Off Calibration Mode: High CRI Calibration Mode: High Output Reset All Null
	030-039	
	040-049	
	050-059	
	060-069	
	070-079	
	080-089	
	090-099	
	100-119	
	120-129	
	130-139	
	140-149	
	150-159	
	160-169	
	170-179	
	180-189	
	190-199	
200-209		
210-255		

































































37 Channels (Mode 2):

CHANNEL	VALUE	FUNCTION
1	000-255	PAN 0°→540°
2	000-255	PAN FINE
3	000-255	TILT 0°→230°
4	000-255	TILT FINE
5	000-255	ZOOM Wide→Narrow
6	000-255	DIMMER 0%→100%
7	000-255	DIMMER FINE
8	000-007 008-015	STROBE Close Open

	016-131 132-139 140-181 182-189 190-231 232-239 240-247 248-255	Strobe from Slow to Fast Open Fast Close Slow Open from Slow to Fast Open Fast Open Slow Close from Slow to Fast Open Random Strobe from Fast to Slow Open
9	000-255	RED 1 0%→100%
10	000-255	GREEN 1 0%→100%
11	000-255	BLUE 1 0%→100%
12	000-255	WHITE 1 0%→100%
13	000-255	RED 2 0%→100%
14	000-255	GREEN 2 0%→100%
15	000-255	BLUE 2 0%→100%
16	000-255	WHITE 2 0%→100%
17	000-255	RED 3 0%→100%
18	000-255	GREEN 3 0%→100%
19	000-255	BLUE 3 0%→100%
20	000-255	WHITE 3 0%→100%
21	000-255	RED 4 0%→100%
22	000-255	GREEN 4 0%→100%
23	000-255	BLUE 4 0%→100%
24	000-255	WHITE 4 0%→100%
25	000-255	RED 5 0%→100%
26	000-255	GREEN 5 0%→100%

27	000-255	BLUE 5 0%→100%
28	000-255	WHITE 5 0%→100%
29	000-255	RED 6 0%→100%
30	000-255	GREEN 6 0%→100%
31	000-255	BLUE 6 0%→100%
32	000-255	WHITE 6 0%→100%
33	000-255	RED 7 0%→100%
34	000-255	GREEN 7 0%→100%
35	000-255	BLUE 7 0%→100%
36	000-255	WHITE 7 0%→100%
37	000-029	FUNCTION Null
	030-039	Dimmer Curve: Linear
	040-049	Dimmer Curve: Square Law
	050-059	Dimmer Curve: Inverse Square Law
	060-069	Dimmer Curve: S Curve
	070-079	Null
	080-089	Dimmer Speed: Smooth
	090-099	Dimmer Speed: Fast
	100-119	Null
	120-129	Zoom Invert Enable
	130-139	Zoom Invert Disable
	140-149	Pan/Tilt Reset
	150-159	Effect Reset
	160-169	Color Calibration: On
170-179	Color Calibration: Off	
180-189	Calibration Mode: High CRI	
190-199	Calibration Mode: High Output	
200-209	Reset All	
210-255	Null	

LED PIXEL SELECT FOR 17-CH:

 Value: 0-3	 Value: 4-7	 Value: 8-11	 Value: 12-15	 Value: 16-19	 Value: 20-23	 Value: 24-27	 Value: 28-31
 Value: 32-35	 Value: 36-39	 Value: 40-43	 Value: 44-47	 Value: 48-51	 Value: 52-55	 Value: 56-59	 Value: 60-63
 Value: 64-67	 Value: 68-71	 Value: 72-75	 Value: 76-79	 Value: 80-83	 Value: 84-87	 Value: 88-91	 Value: 92-95
 Value: 96-99	 Value: 100-103	 Value: 104-107	 Value: 108-111	 Value: 112-115	 Value: 116-119	 Value: 120-123	 Value: 124-127
 Value: 128-131	 Value: 132-135	 Value: 136-139	 Value: 140-143	 Value: 144-147	 Value: 148-151	 Value: 152-155	 Value: 156-159
 Value: 160-163	 Value: 164-167	 Value: 168-171	 Value: 172-175	 Value: 176-179	 Value: 180-183	 Value: 184-187	 Value: 188-191
 Value: 192-195	 Value: 196-199	 Value: 200-203	 Value: 204-207	 Value: 208-211	 Value: 212-215	 Value: 216-219	 Value: 220-223
 Value: 224-227	 Value: 228-231	 Value: 232-235	 Value: 236-239	 Value: 240-243	 Value: 244-247	 Value: 248-251	 Value: 252-255

07/ Error Information

Error codes are shown continuously in the display when the fixture fails and they will not disappear until the fixture is repaired.

CPU-B/C/D Error

Check whether the 485 (DATA) leads on the PCB board are installed in place or disconnected.

Check whether the related 485 (DATA) signal circuit on the PCB board is damaged.

LED Temperature Error

Check whether the temperature detecting board is normal.

Check whether the components of the temperature detecting board are damaged.

Check whether the lead on the temperature detecting board is installed in place or disconnected.

LED Timeout Use

LED Too Hot Off

When the fixture temperature reaches 82°C, it will automatically turn off to protect the fixture.

Color Cal IC Error

Check if the color calibration IC is damaged.

Check whether the color calibration IC board is inserted well and whether the electronic components are well soldered.

Check if the motherboard is malfunctioning.

Check whether the R76 bit resistors and other components on the motherboard are well soldered.

Pan Reset Error

Check whether the position of the pan where the magnet is installed falls off or is damaged.

Check whether there are obstacles in the pan operating range.

Check whether the Hall element on the pan is damaged.

Check whether the lead connecting the Hall element on the pan and the PCB board is in poor contact or disconnected.

Check whether the motor on the pan is damaged.

Check whether the related circuit of the motor drive board on the pan is damage.

Pan Encode Error

Check whether the encoder on the pan is damaged.

Check whether the lead connecting the encoder on the pan and the PCB board is in poor contact or disconnected.

Pan Encode Not Find

Check whether the lead connecting the encoder on the pan and the PCB board is in poor contact or disconnected.

Pan Encode Disable

Check whether the encoder on the pan is damaged.

Tilt Reset Error

Check whether the position of the tilt where the magnet is installed falls off or is damaged.

Check whether there are obstacles in the tilt operating range.

Check whether the Hall element on the tilt is damaged.

Check whether the lead connecting the Hall element on the tilt and the PCB board is in poor contact or disconnected.

Check whether the motor on the tilt is damaged.

Check whether the related circuit of the motor drive board on the tilt is damage.

Tilt Encode Error

Check whether the encoder on the tilt is damaged.

Check whether the lead connecting the encoder on the tilt and the PCB board is in poor contact or disconnected.

Tilt Encode Not Find

Check whether the lead connecting the encoder on the tilt and the PCB board is in poor contact or disconnected.

Tilt Encode Disable

Check whether the encoder on the tilt is damaged.

Zoom Reset Error

Check whether the position of the zoom where the magnet is installed falls off or is damaged.

Check whether there are obstacles in the zoom operating range.

Check whether the Hall element on the zoom is damaged.

Check whether the lead connecting the Hall element on the zoom and the PCB board is in poor contact or disconnected.

Check whether the motor on the zoom is damaged.

Check whether the related circuit of the motor drive board on the zoom is damage.

Base Fan / Head Fan Start Error

Check whether the fan is not running.

Check whether the fan leads are installed in place or disconnected.

Check whether the fan is damaged.

Check whether there are obstacles in the fan operating range.

Base Fan / Head Fan Too Slow

Check whether the fan is out of order.

Check whether there are obstacles in the fan operating range.

Base Fan / Head Fan Too Fast

Check whether the fan is out of order.

Check whether the fan circuit on the motherboard breaks down.

The position of each fan of the fixture:

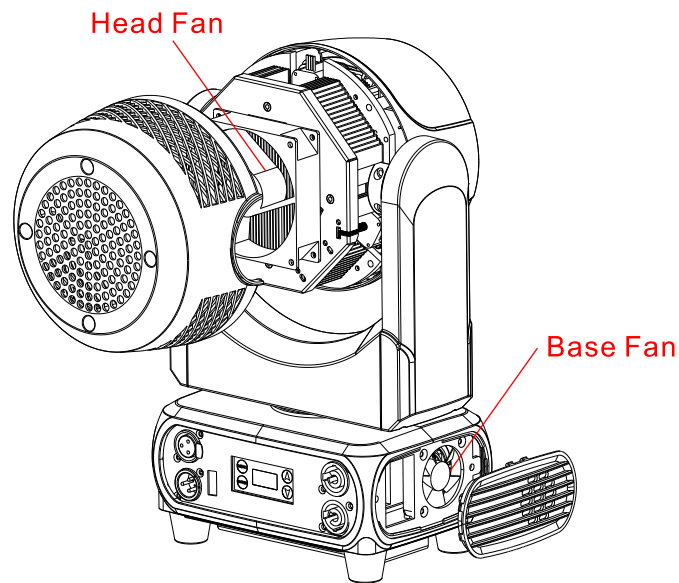

08/ Troubleshooting

Following are a few common problems that may occur during operation. Here are some suggestions for troubleshooting:

A. The unit does not work, no light and the fan does not work

- ▶ Check the connected power.
- ▶ Measure the voltage.
- ▶ Check the power indicator to see whether it can be lit up or not.

B. Not responding to the DMX controller

- ▶ Check whether the DMX connectors and the DMX cables are connected correctly.
- ▶ Check whether the DMX address is correctly set.
- ▶ If the intermittent DMX signal problem occurs, check whether the XLR socket and the signal cable are well connected.
- ▶ Try it with another DMX controller.
- ▶ Check whether the DMX cables run near or alongside to the high-voltage cables, which may damage or interfere with the signal circuit.

C. One of the channels is not working well

- ▶ The stepper motor might be damaged or the cable connected to the PCB might be broken.
- ▶ The motor's drive IC on the PCB might be out of condition.

09/ Fixture Cleaning

It is absolutely essential that the fixture is kept clean to ensure the maximum light-output and allow the fixture to function reliably throughout its life. The fixture must be cleaned regularly to avoid dust, dirt and smoke-fluid residues building up on or within the fixture. The cleaning frequency depends on the application environment. Clean the fixture immediately if the dust enters it to avoid damage to the optical lens due to excessive dust.

- ▶ A soft lint-free cloth moistened with any good glass cleaning fluid is recommended, under no circumstances should solvents be used.
- ▶ Always dry the parts carefully.
- ▶ Clean the external optical lens at least every 20 days.

Declaration of Conformity

We declare that our products (lighting equipments) comply with the following specification and bears CE mark in accordance with the provision of the Electromagnetic Compatibility (EMC) Directive 2014/30/EU.

EN 55032: 2015+A11: 2020; EN 55035: 2017+A11: 2020;
EN IEC 61000-3-2: 2019+A1: 2021;
EN 61000-3-3: 2013+A1: 2019+A2: 2021.

&

Harmonized Standard

EN IEC 60598-2-17: 2018;
EN IEC 60598-1: 2021/A11: 2022.
Safety of household and similar electrical appliances
Part 1: General requirements and tests

Certifications

cETLus Approved (Control #5000057)



www.acme.com.cn