

THETA

CM 1000ZF



Light Source

Beam: **1 x 200W LED**

Wash: **30 x 40W RGBW LED**

Total Lumen Output of Fixture

4,000 lumens (200W LED)

Zoom Range

4°-51° (40W RGBW LED)

Acme

THETA



Main Features

Light Source:

Beam: 200W CW LED

Wash: 30 x 40W RGBW LED

Color Temperature Output of Fixture: 7,000K (200W LED)

Total Lumen Output of Fixture: 5,000 lumens (200W LED)

Linear variable from 2,500-8,000K

(40W RGBW LED)

Individual pixel control, build-in color macro effect

Automated color correction system to ensure

a consistent output

1 Static Gobo Wheel:

6 gobos and 3 effect gobos, plus open

1 Color Wheel: 13 colors, plus open

2 Prisms: 1 x 8-facet prism, 1 x 16-facet prism,
rotatable in both directions and overlayable

1 frost filter

Zoom function on the outer ring

Motorized focus

Variable light adjustment from 0 to 100%

Flicker free management

Technical Specifications

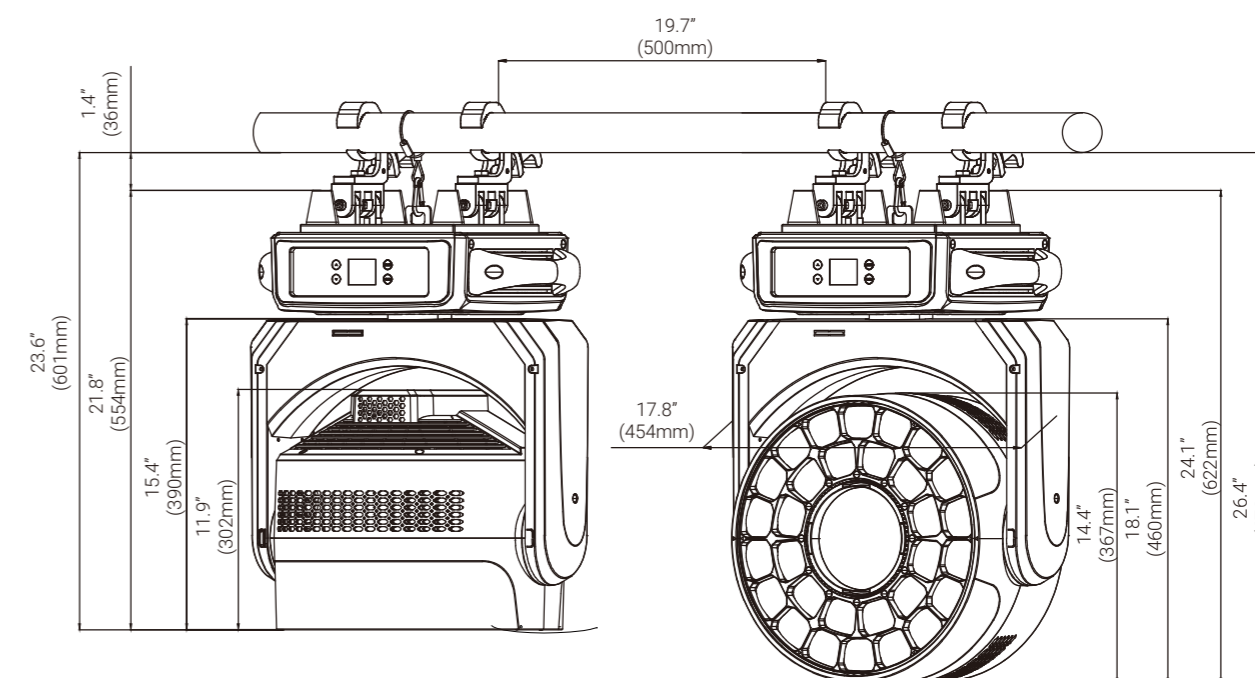

Light Source

- Light Source:
- Beam: 200W LED
- Wash: 30 x 40W RGBW LED
- Color Temperature Output of Fixture: 7,000K (200W LED)
- Total Lumen Output of Fixture: 4,000 lumens (200W LED)
- Life Expectancy: 20,000 hours*
- *Source manufacturer specification

Optical System

- Beam Angle: 3° (200W LED)
- Zoom Range: 4°-51° (40W RGBW LED)

Prism / Frost Filter

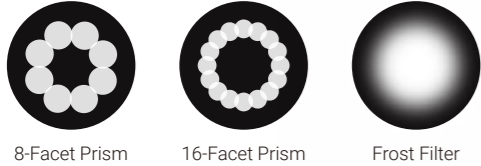

8-Facet Prism 16-Facet Prism Frost Filter

Colors

- Linear variable from 2,500-8,000K (40W RGBW LED)



- 1 Color Wheel: 13 colors, plus open

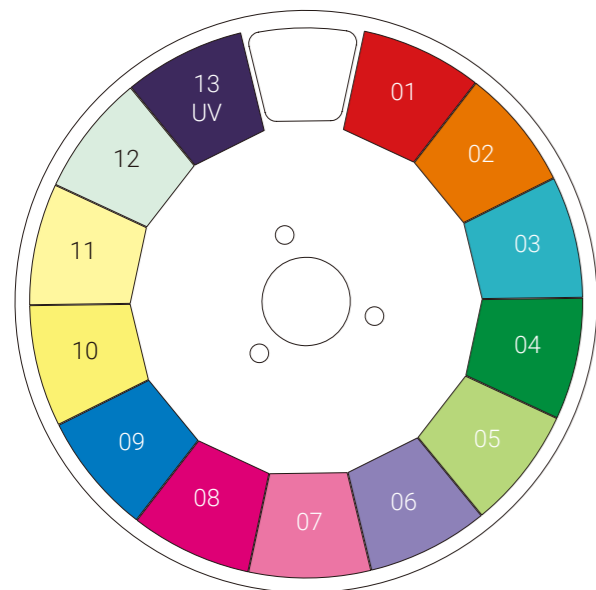

Color Wheel

Static Gobos

- 1 Static Gobo Wheel:
- 6 gobos and 3 effect gobos, plus open

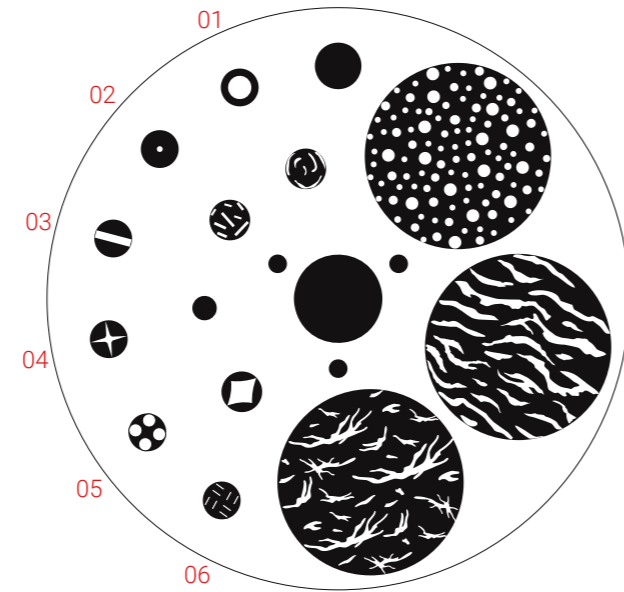

Static Gobo Wheel

Other Effects

- Outstanding strobe effect with variable speed
- Motorized zoom and focus
- Smooth dimming 0-100%
- Flicker free management



Linear Iris

Pan & Tilt

- Pan Movement: 540°
- Tilt Movement: 215°
- Automatic Pan/Tilt position correction
- Movement is 16 bit resolution

Control

- 4 touch button control panel
- Display: LCD display
- Protocols: DMX512, RDM, Art-Net, sACN
- DMX Protocol Modes: 4
- Control Channels: 19/27/139/141
- Firmware Upgrade: Upgrade via DMX link

Electrical and Connectors

- Input Voltage Range: 100-240Vac; 50/60Hz
- Power Consumption: 1,600W
- Power In/Out: Power connectors (TRUE1 type)
- Data In/Out: 3-pin and 5-pin XLR, RJ45 connector

Physical Information

- Fixture Dimensions: 454 x 341 x 590 mm (46.1" x 28" x 23.2")
- Weight: 33.0 kg (72.8 lbs)

Packing Information

- Flight Case Dimensions: 1,220 x 685 x 645 mm (48.0" x 27.0" x 25.4")
- Weight: 122.5 kg (270.1 lbs) (two-pack loader case)
- Carton Dimensions: 560 x 470 x 675 mm (22.1" x 18.5" x 26.6")
- Weight: 40.0 kg (88.2 lbs) (one-pack loader carton)

Work Environment

- Maximum Ambient Temperature: 40°C
- Minimum Operating Temperature: 0°C
- Maximum Surface Temperature: 65°C
- Protection Rating: IP20

Installation

- Horizontally or vertically mounting
- Universal working position
- 2 x omega brackets
- Safety cable attachment point

Photometric (Images)

Beam Angle (1 x 200W LED):

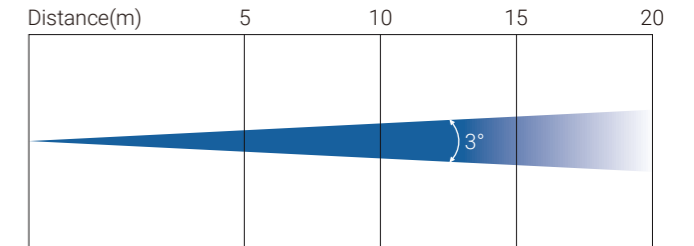

3° Lux	123,616	30,904	13,735	7,726
Diameter(m)	0.3	0.5	0.8	1.0

Beam Angle (30 x 40W RGBW LED):

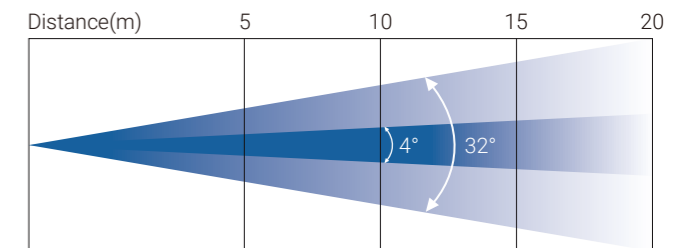

4° Lux	55,000	13,750	6,111	3,437
Diameter(m)	0.4	0.7	1.1	1.4
32° Lux	2380	595	264	148
Diameter(m)	2.9	5.7	8.6	11.5

Field Angle (30 x 40W RGBW LED):

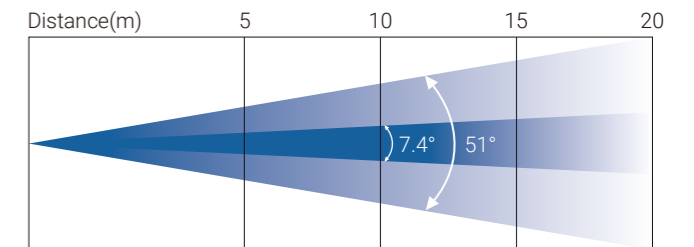

7.4° Lux	55,000	13,750	6,111	3,437
Diameter(m)	0.6	1.3	1.9	2.6
51° Lux	2380	595	264	148
Diameter(m)	4.7	9.4	14.2	18.9



Specifications subject to change without notice.