

LYRA

XA 1000 BSWF IP



Light Source

1,000W LED

Diameter of Front Lens

160 mm

Total Lumen Output of Fixture (Ra>70)

35,000 lumens

Zoom Range

6°-50°

Protection Rating

IP66

Acme

LYRA



Main Features

High Efficiency 1,000W, 8,000K white LED

Diameter of Front Lens: 160 mm

Zoom Range: 6°-50°

Total Lumen Output (Ra>70): 35,000 lumens

HCRI Mode Output (Ra>90): 25,600 lumens

Color Temperature Output of Fixture: 6,500K

Standard mode Ra>70, HCRI Mode Ra>90

Linear CMY color mixing

Variable CTO ranging from: 2,700K-6,500K

Animation Wheel: 1 graphic animation wheel with continuous rotation in both directions

2 Prisms: 1 x 4-facet prism, 1 x 4-facet linear prism, rotatable in both directions

1 combinable light frost filter and 1 combinable medium frost filter individually controllable; Rotation of the framing system module: ±60°

Flicker free management from 900Hz to 25,000Hz

Smooth dimming 0-100%

1 Color Wheel: 5 colors + CRI + frost

Static Gobo Wheel: 9 gobos plus open

Rotating Gobo Wheel: 7 indexable and interchangeable gobos

Technical Specifications

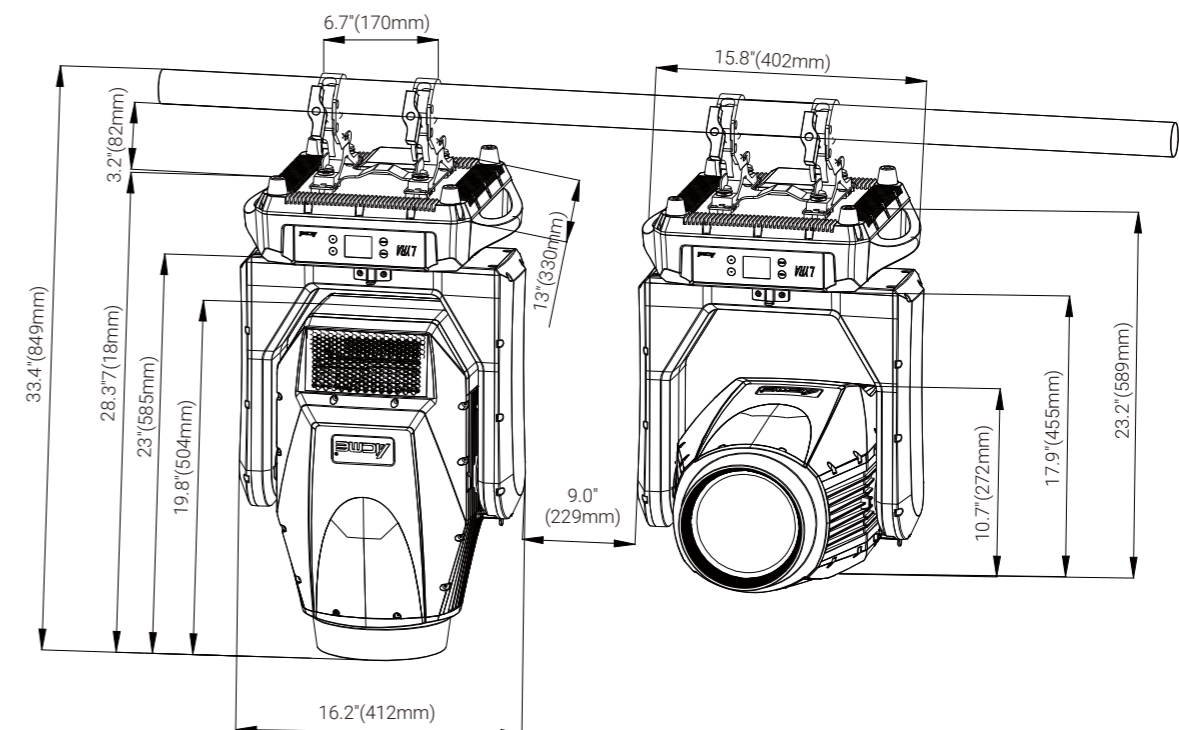

Light Source

- Light Source: 1,000W 8,000K White LED
- Color Temperature Output of Fixture: 6,500K
- Total Lumen Output (Ra>70): 35,000 lumens
- HCRI Mode Output (Ra>90): 25,600 lumens
- Life Expectancy: 20,000 hours*

*Source manufacturer specification

Optical System

- Zoom Range: 6°-50°
- Front Lens Diameter: 160 mm

Prism / Frost Filter

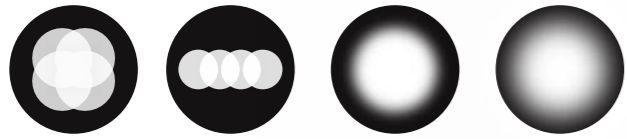

4-Facet Prism 4-Facet Linear Prism Light Frost Filter Medium Frost Filter

Colors

- Linear CMY Color Mixing



- Linear CTO Color Correction: 2,700K-6,500K



- 1 Color Wheel: 5 colors + CRI + frost

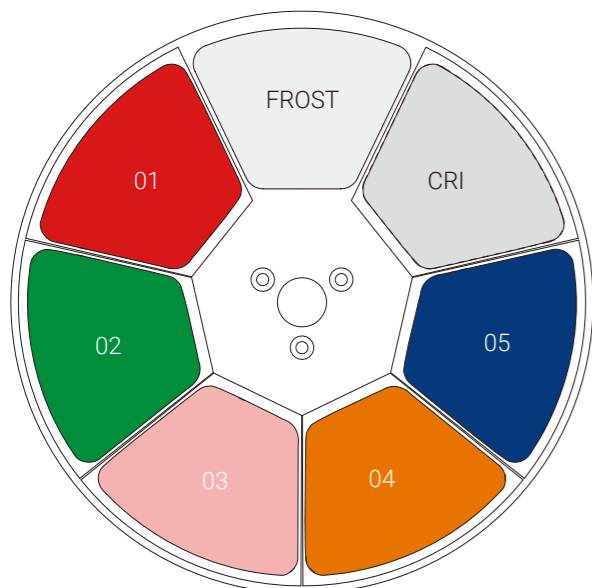

Color Wheel

Static Gobos

- 1 Static Gobo Wheel: 9 gobos, plus open

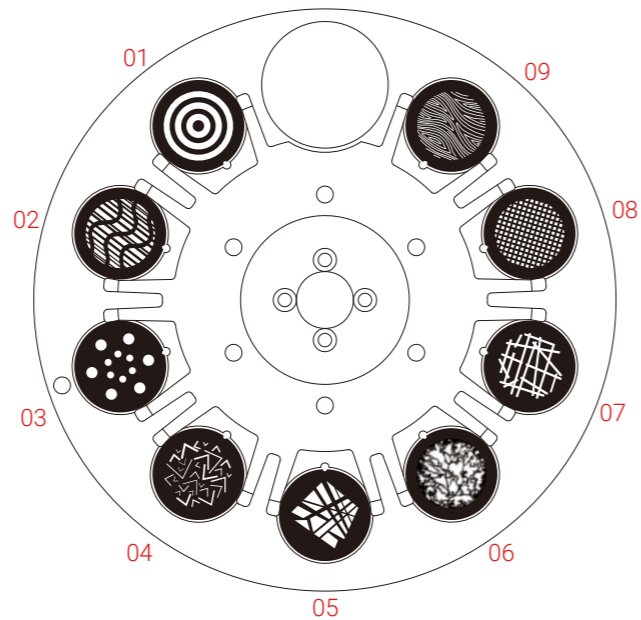

Static Gobo Wheel

- 1 Rotating Gobo Wheel:
- 7 replaceable gobos, plus open
- Gobo Diameter: 22.5 mm
- Image Diameter: 17 mm

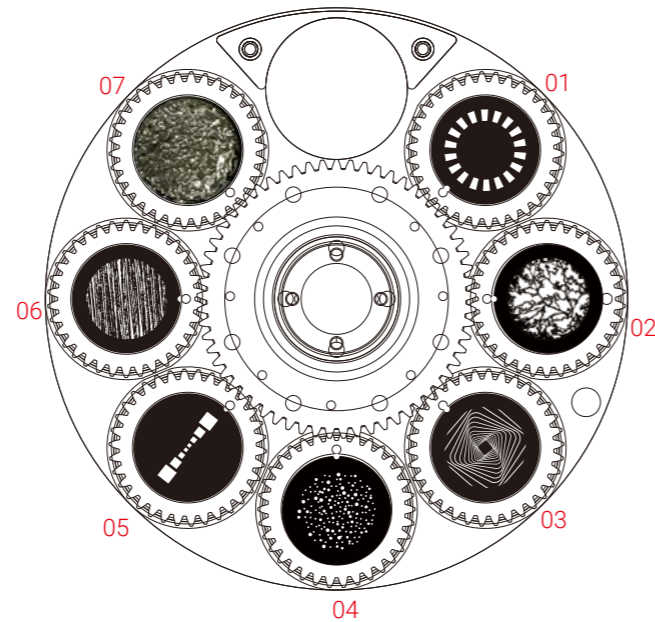

Rotating Gobo Wheel

Framing System

- Shutter Blades: 4 Blades, each with separate movement and full blackout
- Movement: Smooth with variable speed, ultrafast for creating mid-air effects
- Positioning: The blades can be precisely positioned
- Rotation: ±60° of the complete framing system

Animation Wheel

- A graphic animation wheel with continuous rotation in both directions, used alone or in combination with gobos to create the splendid water wave & flame effect, and can be changed into other wheels

Others Effects

- Motorized zoom and focus
- Motorized linear iris

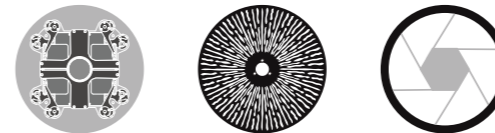

Framing Module Animation Wheel Linear Iris

PAN & TILT

- Pan movement: 540°
- Tilt movement: 260°
- Automatic Pan/Tilt position correction
- Moving-head operated with 16 bit resolution
- Fixation: Pan/ Tilt lock

Control

- 4 button touch control panel
- Display: LCD display
- Protocols: DMX512, RDM
- DMX Protocol Modes: 5
- Control Channels: 22/30/31/39/40
- Firmware Upgrade: Upgrade via DMX link

Electrical and Connections

- Input Voltage Range: 100-240Vac; 50/60Hz
- Power Consumption: 1,190W
- Power In/Out: Waterproof power connectors in/out (TRUE1 type)
- Data In/Out: 3-pin or 5-pin waterproof XLR

Physical Information

- Fixture Dimensions: 412 x 330 x 718 mm (16.2" x 13.0" x 28.3")
- Weight: 42.0 kg (92.6 lbs)

Packing Information

- Flight Case Dimensions 1: 1,140 x 760 x 840 mm (44.9" x 29.9" x 33.1")
- Weight: 166.0 kg (366.0 lbs) (two-pack loader case)
- Flight Case Dimensions 2: 620 x 590 x 850 mm (24.4" x 23.2" x 33.5")
- Weight: 83.0 kg (183.0 lbs)(two-pack loader case)

Work Environment

- Maximum Ambient Temperature: 40°C
- Minimum Operating Temperature: -10°C
- Maximum Surface Temperature: 85°C
- Protection Rating: IP66

Installation

- Horizontal or vertical mounting
- Universal working positions
- 2, 1/4-turn locking points on the base
- Safety cable attachment point

Photometric (Images)

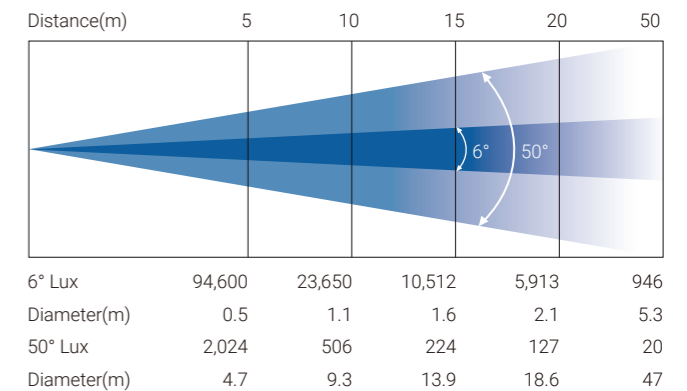

Specifications subject to change without notice.

10/17/2024