

PHOTON HYBRID 500

Outdoor Moving Laser Hybrid

SPEC SHEET



Foshan YiFeng Electric Industrial Co.,Ltd.

No.898, Gaoming Avenue East, Hecheng Blvd, Gaoming District, Foshan, Guangdong, China.

Web: www.acmelighting.com Email: sales@acmelighting.com

All rights reserved by Acme®. Features, specifications and appearance are subject to change without notice.

REV: 27/02/2026

Acme®

PHOTON HYBRID 500

Outdoor Moving Laser Hybrid

SPEC SHEET

FIXTURE OVERVIEW

- The **PHOTON HYBRID 500** is ACME's first moving laser hybrid fixture, marking a new era in moving head. Designed for long-throw performance, ultra-clear gobo projection, and minimal maintenance, the IP66 fixture delivers versatility beyond expectations.
- Featuring an iconic moving-head form, the **PHOTON HYBRID 500** is equipped with a unique 350W white laser source and a large 180 mm frontal lens, delivering remarkable beam quality and high-impact visuals for large-format outdoor stages. Its high illuminance produces punchy beams that command attention, even under bright outdoor light. The fixture projects ultra-intense 0.9° beams visible even from a long distance. With three switchable zoom modes, it transitions seamlessly from sharp, focused beams to wide, even washes, meeting the demands of diverse lighting designs.
- To unlock limitless color possibilities, the fixture features a variable CTO for instant color temperature adjustments, a color mixing system for smooth transitions, and a rotating color wheel with 16 vibrant colors. Packed with creative potential, the fixture comes with a 21-static-gobo wheel and an 11-rotating-gobo wheel, producing crisp, well-defined gobo projections. Four prisms can be overlaid in pairs for enhanced layered visual effects, while a frost filter softens beam edges for uniform washes.
- Built for outdoor reliability, the IP66-rated fixture ensures stable, high-performance output in any environment. Its Sunlight Protection Mode can automatically adjust the head to a safe direction after power-off, protecting internal optics from direct sunlight.
- With intense brightness, versatile effects, and striking visuals, the **PHOTON HYBRID 500** delivers exceptional beam quality and creative flexibility for large-scale performances and landscape applications.



FEATURE HIGHLIGHTS

- Light Source: 350W white laser source
- 180 mm diameter frontal lens
- Zoom Range:
 - Beam: 0.9°-22°
 - Spot: 3.5°-29°
 - Wash: 4.5°-40°
- Light Engine Luminous Output: 20,000 lumens
- Fixture Luminous Output: 16,900 lumens
- Color Temperature Output of Fixture: 8,000K
- Linear CMY color mixing
- Variable CTO ranging from 3,200K-8,000K
- 1 Color Wheel: 16 colors + CRI, plus open
- 1 Static Gobo Wheel: 21 gobos, plus open
- 1 Rotating Gobo Wheel: 11 gobos, plus open

Foshan YiFeng Electric Industrial Co.,Ltd.

No.898, Gaoming Avenue East, Hecheng Blvd, Gaoming District, Foshan, Guangdong, China.

Web: www.acmelighting.com Email: sales@acmelighting.com

All rights reserved by Acme®. Features, specifications and appearance are subject to change without notice.

REV: 27/02/2026

ACME®

PHOTON HYBRID 500

Outdoor Moving Laser Hybrid

SPEC SHEET

FEATURE HIGHLIGHTS

- 4 Prisms: 1 x 4-facet circular prism, 1 x 8-facet circular prism, 1 x 4-facet linear prism, 1 x 6-facet linear prism, enabling dual-prism overlay effects
- 1 frost filter
- Outstanding strobe effect with variable speed
- Smooth dimming 0-100% (4 user selectable dimming curves)
- Motorized focus system
- IP66 rated

TECHNICAL SPECIFICATIONS

Model

- Model Name: PHOTON HYBRID 500
- Model Code: XL 500 BSW IP

Light Source

- Light Source: 350W white laser source
- Life Expectancy: 12,000 hours*
- *Source manufacturer specification*

Photometric Data

- Light Engine Luminous Output: 20,000 lumens
- Fixture Luminous Output: 16,900 lumens
- CCT: 8,000K (+/- 200K)
- CRI: 69
- TM-30 Rf (IES TM-30-15 Fidelity Index): 66
- TM-30 Rg (IES TM-30-15 Fidelity Index): 89
- TLCI: 39
- CQS: 68
- Peak Luminous Intensity: 8,433,000 cd

Optical System

- Diameter of Frontal Lens: 180 mm
- Zoom Range:
 - Beam: 0.9°-22°
 - Spot: 3.5°-29°
 - Wash: 4.5°-40°

Control & Program

- 4 touch button control panel
- Display: LCD display
- Protocols: DMX, RDM, Art-Net, sACN, NFC
- Setting and Addressing: Display menu, RDM
- DMX Modes: 2
- DMX Channels: 28/31
- Firmware Upgrade: Upgrade via DMX link or USB stick

Pan & Tilt

- Pan: 540°
- Tilt: 270°
- Automatic Pan/Tilt position correction
- Resolution: 16 bit
- Pan/Tilt lock

Color Mixing

- Linear CMY color mixing

Color Correction

Linear CTO Color Correction: 3,200K- 8,000K

Color Wheel

- 1 Color Wheel: 16 colors + CRI, plus open

PHOTON HYBRID 500

Outdoor Moving Laser Hybrid

SPEC SHEET

TECHNICAL SPECIFICATIONS

Static Gobo Wheel

- 1 Static Gobo Wheel: 21 gobos, plus open
- Gobo Dimensions
 - External Diameter: 86 mm (3.4")
- Coating: Black high-temp resistant coating
- Material: Aluminum alloy

Rotating Gobo Wheel

- 1 Rotating Gobo Wheel: 11 gobos, plus open

Frost

- 1 frost filter

Focus

- Motorized focus system

Prism

- 4 Prisms: 1 x 4-facet circular prism, 1 x 8-facet circular prism, 1 x 4-facet linear prism, 1 x 6-facet linear prism, enabling dual-prism overlay effects

Electrical

- Input Voltage Range: 100-240Vac; 50/60Hz
- Power Consumption: 660W
- Power In/Out: Waterproof power connector in/out
- Data In/Out: 3-pin or 5-pin waterproof XLR, waterproof RJ45 connector

Physical

- Weight: 32.5 kg (71.7 lbs)
- Length (Head): 500 mm (19.7")
- Length (Base): 380 mm (15")
- Width (Across Yoke): 371 mm (14.6")
- Height (Head Up): 679 mm (26.8")

Construction

- Housing: Aluminum-magnesium alloy
- Color: Black
- Protection Rating: IP66

Work Environment

- Maximum Ambient Temperature: 45°C
- Minimum Operating Temperature: -20°C
- Maximum Surface Temperature: 70°C

Acoustic Data

- Noise Level:
 - Standard Mode: 51 dB(A) @ 1 m
 - Quiet Mode: 46 dB(A) @ 1 m
 - Theater Mode: 41 dB(A) @ 1 m

Installation

- Universal working position
- 2 omega brackets
- Safety cable attachment point

Approvals

- CE compliant (on going)
 - EMC directive 2014/30/EU
 - LVD directive 2014/35/EU
- UKCA compliant (on going)
 - Electromagnetic Compatibility Regulations 2016
 - Electrical Equipment (Safety) Regulations 2016

PHOTON HYBRID 500

Outdoor Moving Laser Hybrid

SPEC SHEET

INCLUDED ITEMS

Included Items

- Digital user manual
- Power cable
- 2 omega brackets (3002003002)

ORDERING INFORMATION

Optional Accessories (With Order Code)

- Flight Case
Standard: Two-pack loader case (63584351)
- Clamp: C-250B (2060001632-B)
- Safety Cable: SW-05 (2060001603-E)
- Signal Cable:
3-pin waterproof signal cable (3017013468) or
5-pin waterproof signal cable (3017013473)

Carton Dimensions

- Carton Dimensions:
 - Width: 640 mm (25.2")
 - Depth: 490 mm (19.3")
 - Height: 715 mm (28.2")
- Weight:
G.W.: 40 kg (88.2 lbs) (one-pack loader carton)



3-pin/5-pin waterproof
signal cable: 3017013468/3017013473



SW-05: 2060001603-E



C-250B: 2060001632-B



Standard : Two-pack loader case (63584351)

Foshan YiFeng Electric Industrial Co.,Ltd.

No.898, Gaoming Avenue East, Hecheng Blvd, Gaoming District, Foshan, Guangdong, China.

Web: www.acmelighting.com Email: sales@acmelighting.com

All rights reserved by Acme®. Features, specifications and appearance are subject to change without notice.

REV: 27/02/2026

Acme®

PHOTON HYBRID 500

Outdoor Moving Laser Hybrid

SPEC SHEET

(STANDARD) FLIGHT CASE

APPLICABLE MODELS

- ARES IP (XP 500 BEAM IP)
- ZEUS (XP 500 BSW IP)
- HUE 6 IP (HUE 6 IP)
- PHOTON HYBRID 500 (XL 500 BSW IP)

ORDER CODE

- 63584297 ARES IP (XP 500 BEAM IP)
- 63584148 ZEUS (XP 500 BSW IP)
- 63584232 HUE 6 IP (HUE 6 IP)
- 63584351 PHOTON HYBRID 500 (XL 500 BSW IP)

CASE WEIGHT

- 49 kg (108.1 lbs)

MEAS

- 1,170 x 610 x 795 mm (46.1" x 24.0" x 31.3")

LOADING Q'TY

- Two-pack loader case

MAXIMUM STACKING

- 2 stacks

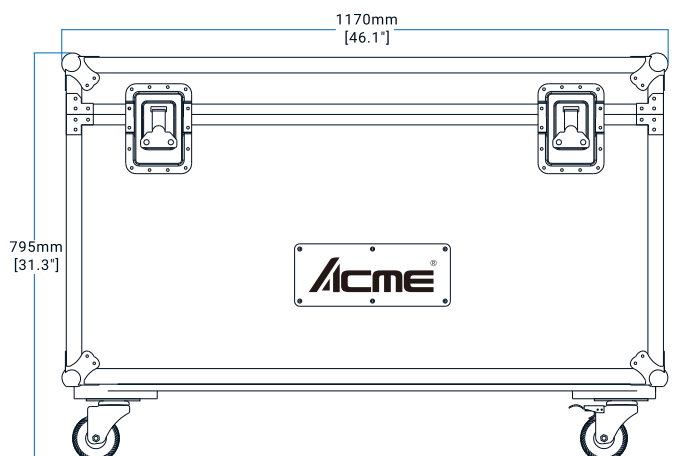
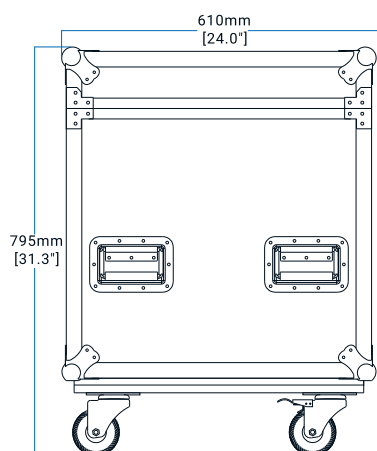
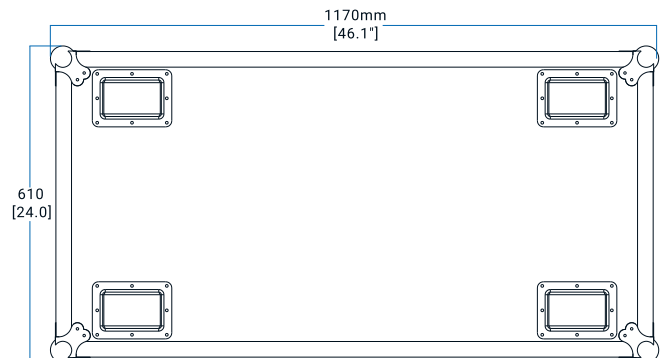
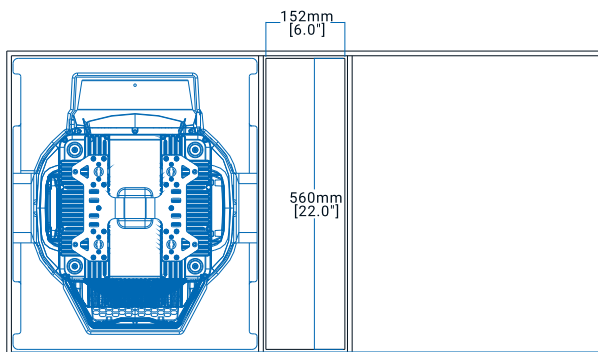

CASE by ACME Version: 20260123-C

Foshan YiFeng Electric Industrial Co.,Ltd.

No.898, Gaoming Avenue East, Hecheng Blvd, Gaoming District, Foshan, Guangdong, China.

Web: www.acmelighting.com Email: sales@acmelighting.com

All rights reserved by Acme®. Features, specifications and appearance are subject to change without notice.

REV: 27/02/2026

Acme®

PHOTON HYBRID 500

Outdoor Moving Laser Hybrid

SPEC SHEET

DIMENSIONS

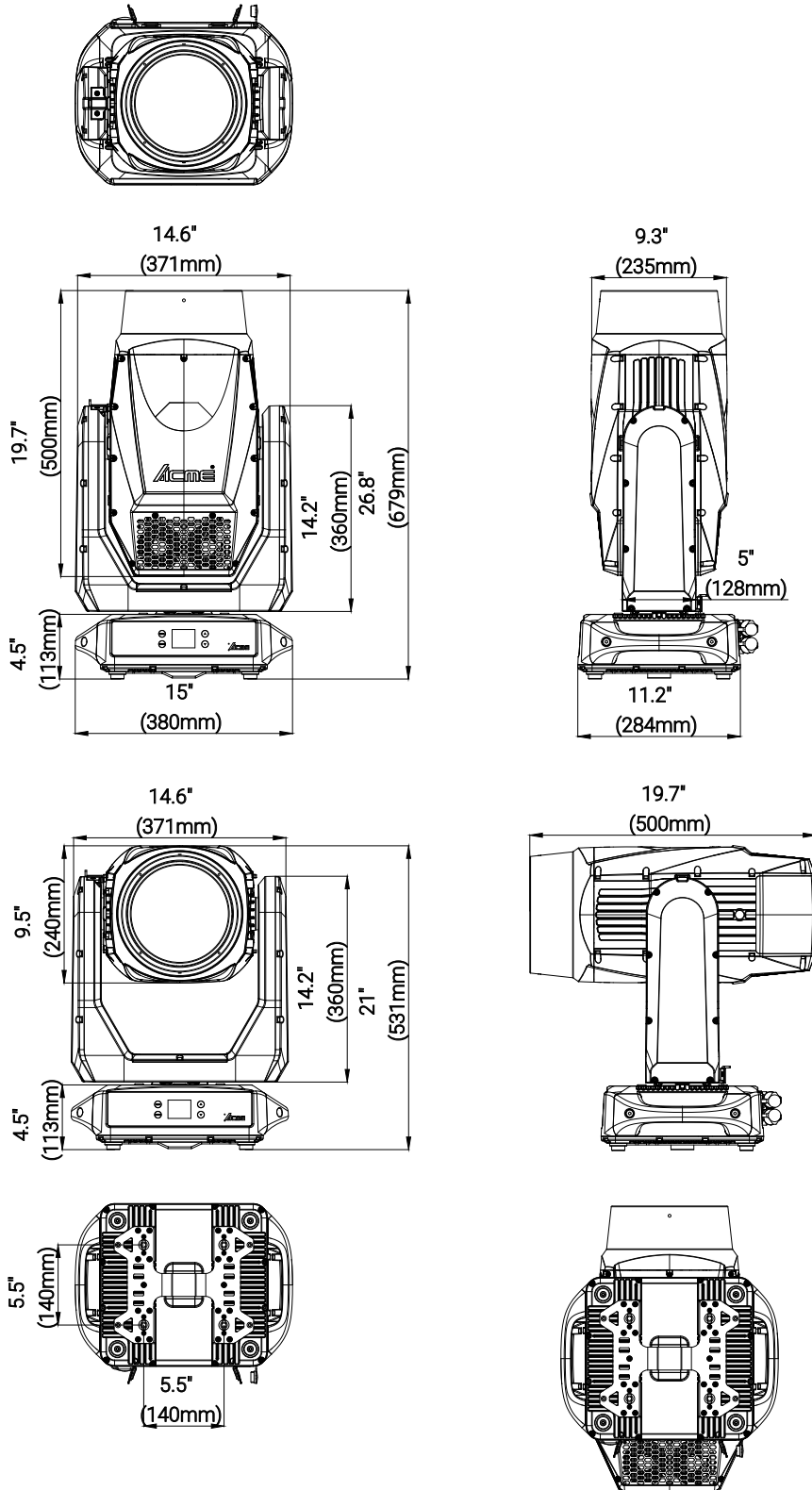

Foshan YiFeng Electric Industrial Co.,Ltd.

No.898, Gaoming Avenue East, Hecheng Blvd, Gaoming District, Foshan, Guangdong, China.

Web: www.acmelighting.com Email: sales@acmelighting.com

All rights reserved by Acme®. Features, specifications and appearance are subject to change without notice.

REV: 27/02/2026

Acme®

PHOTON HYBRID 500

Outdoor Moving Laser Hybrid

SPEC SHEET

HANGING DIMENSIONS

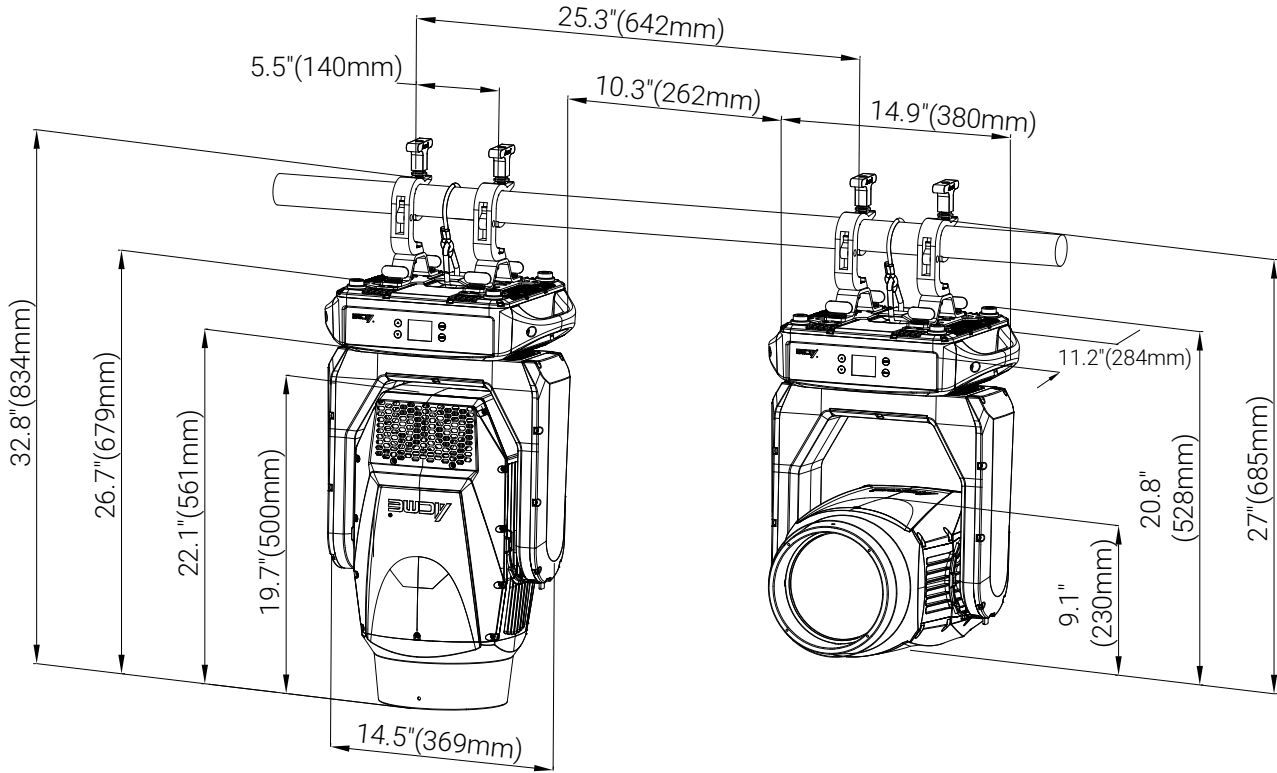

PHOTOMETRIC

Standard Mode

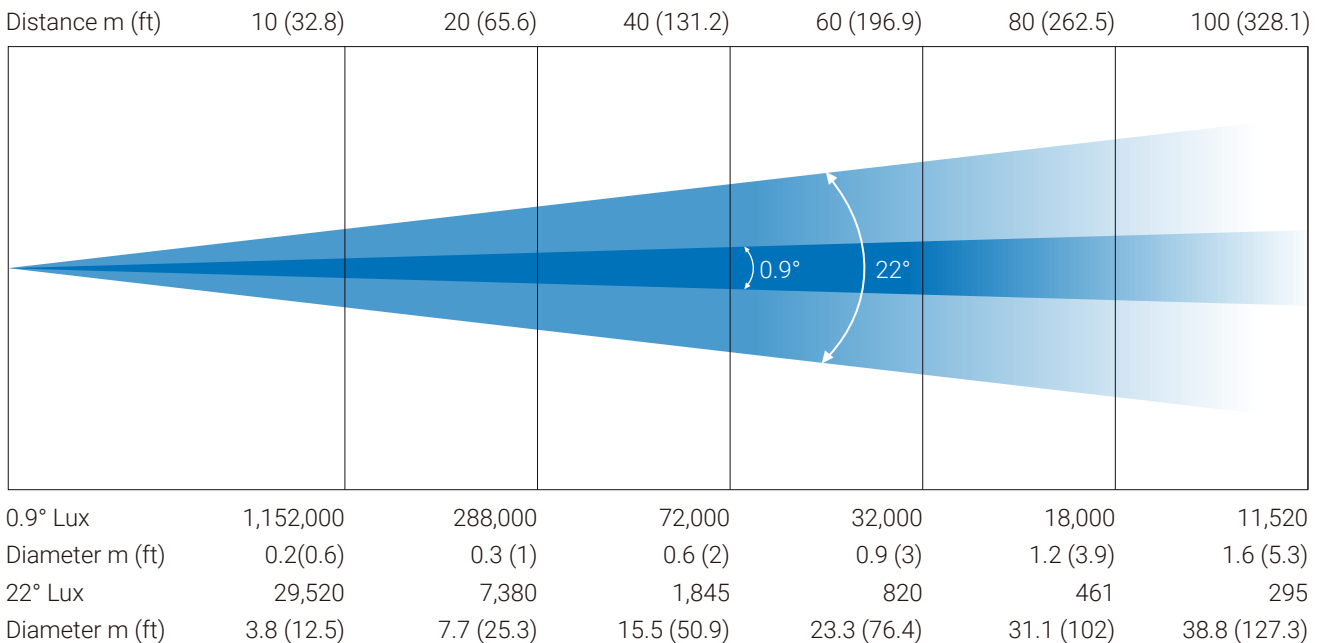

Foshan YiFeng Electric Industrial Co.,Ltd.

No.898, Gaoming Avenue East, Hecheng Blvd, Gaoming District, Foshan, Guangdong, China.

Web: www.acmelighting.com Email: sales@acmelighting.com

All rights reserved by Acme®. Features, specifications and appearance are subject to change without notice.

REV: 27/02/2026



PHOTON HYBRID 500

Outdoor Moving Laser Hybrid

SPEC SHEET

PHOTOMETRIC

Quiet Mode

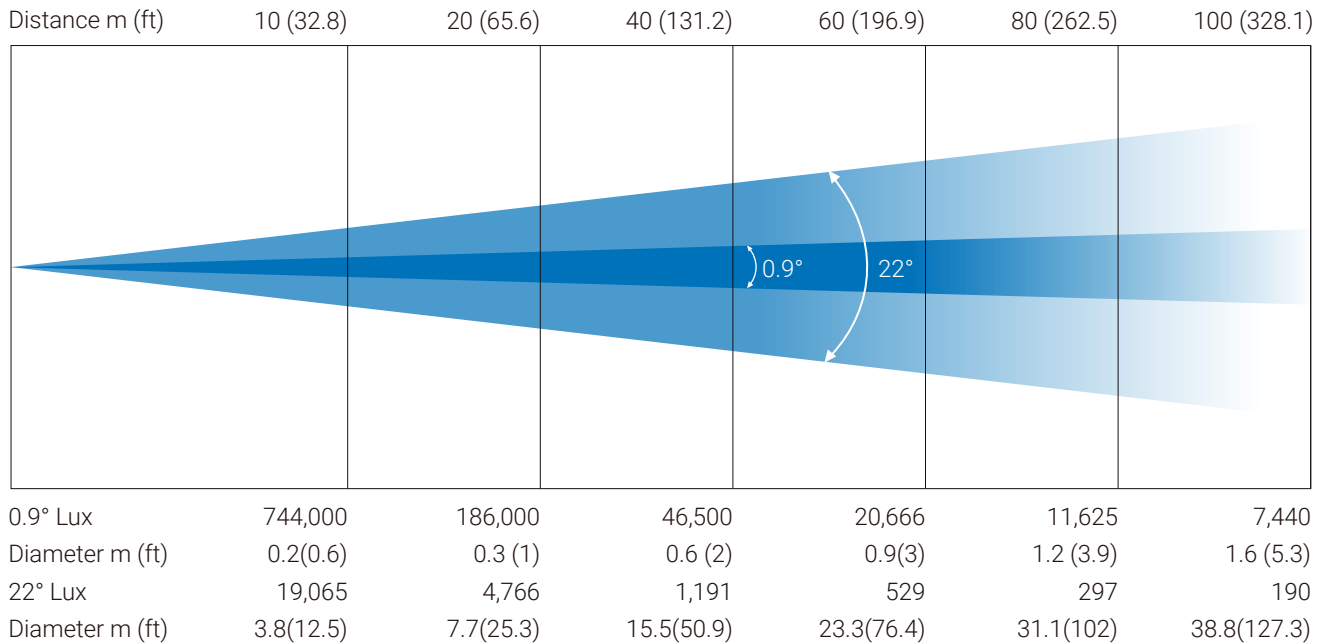

Theater Mode

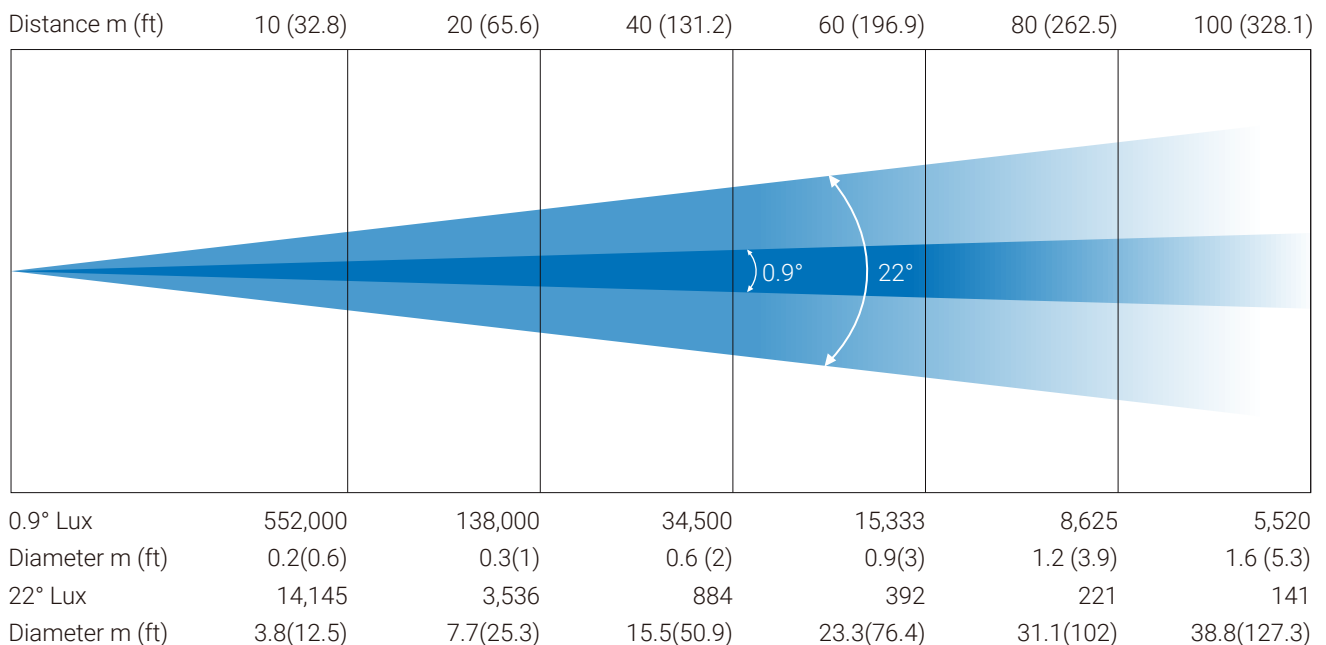

Foshan YiFeng Electric Industrial Co.,Ltd.

No.898, Gaoming Avenue East, Hecheng Blvd, Gaoming District, Foshan, Guangdong, China.

Web: www.acmelighting.com Email: sales@acmelighting.com

All rights reserved by Acme®. Features, specifications and appearance are subject to change without notice.

REV: 27/02/2026



PHOTON HYBRID 500

Outdoor Moving Laser Hybrid

SPEC SHEET

DYNAMIC EFFECTS

Color Wheel

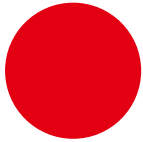

Red
Slot 1

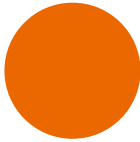

Orange
Slot 2

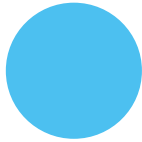

Aqua Marine
Slot 3

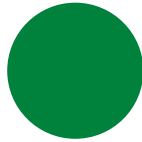

Deep Green
Slot 4

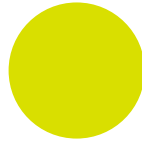

Light Green
Slot 5

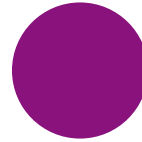

Mauve
Slot 6

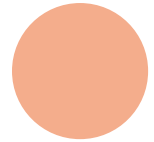

Pink
Slot 7

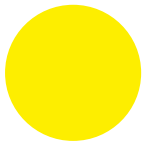

Magenta
Slot 8



Magenta
Slot 9

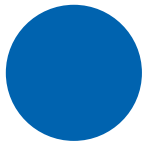

Cyan
Slot 10

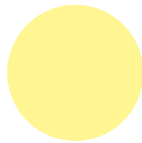

Light Yellow
Slot 11



CTO
Slot 12



Golden Amber
Slot 13



Green
Slot 14



Amber
Slot 15



Blue
Slot 16



CRI
Slot 17

Static Gobo Wheel



Slot 1



Slot 2



Slot 3



Slot 4



Slot 5

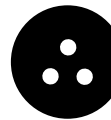

Slot 6

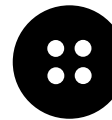

Slot 7

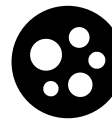

Slot 8

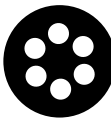

Slot 9



Slot 10

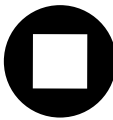

Slot 11

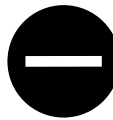

Slot 12



Slot 13



Slot 14



Slot 15



Slot 16



Slot 17



Slot 18



Slot 19



Slot 20



Slot 21

PHOTON HYBRID 500

Outdoor Moving Laser Hybrid

SPEC SHEET

DYNAMIC EFFECTS

Rotating Gobo Wheel

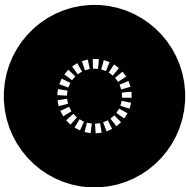

Slot 1

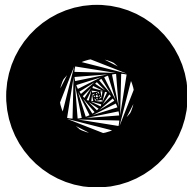

Slot 2

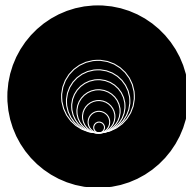

Slot 3

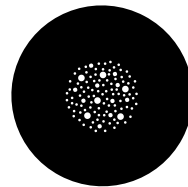

Slot 4

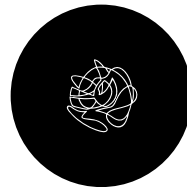

Slot 5

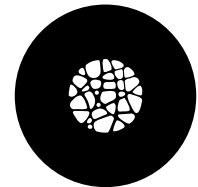

Slot 6



Slot 7

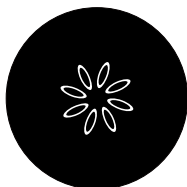

Slot 8

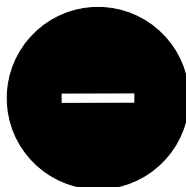

Slot 9

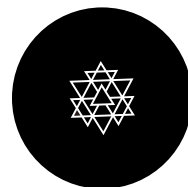

Slot 10



Slot 11

Linear CMY Color Mixing



Linear CTO Color Correction



3,200K-8,000K

Prism/Frost Filter



1 x 4-Facet Circular Prism



1 x 8-Facet Circular Prism

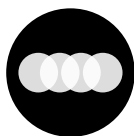

1 x 4-Facet Linear Prism

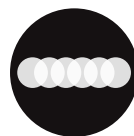

1 x 6-Facet Linear Prism



1 Frost Filter

PHOTON HYBRID 500

Outdoor Moving Laser Hybrid

SPEC SHEET

PHOTOMETRIC REPORT – CHROMATICITY

Spectral Distribution

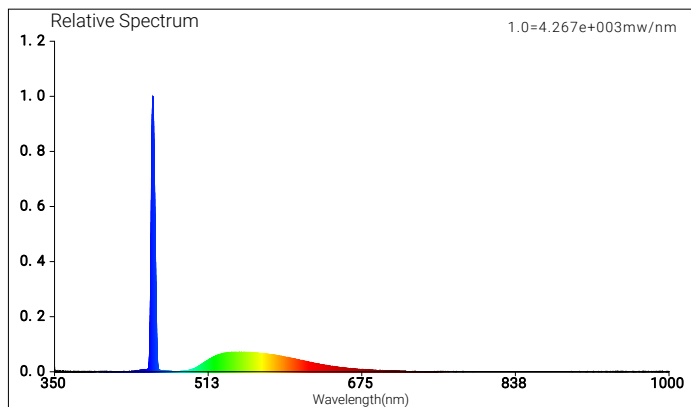

CRI: 70.2 (R1-R8)

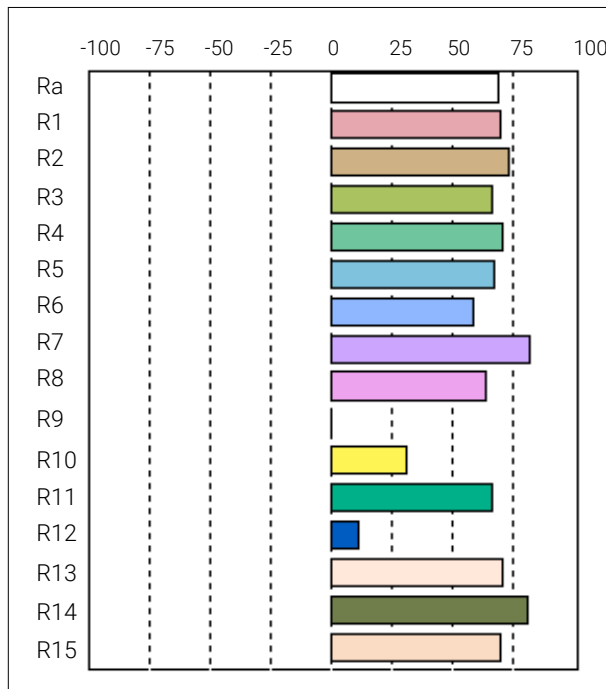

CIE 1931 EVERFINE

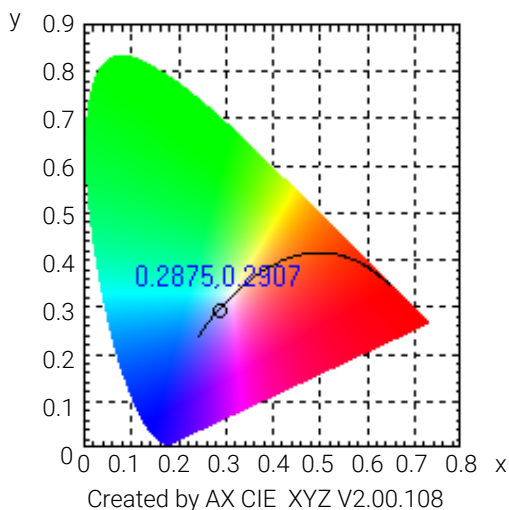

CRI C Values

C1	C2	C3	C4	C5	C6	C7	C8	C9	C10	C11	C12	C13	C14	C15	C16
70.8	74.3	72.4	71.8	68.6	59.5	83.4	64.9	0.0	32.0	67.5	12.3	72.2	82.0	71.2	70.2

TM30 R Values

R1	R2	R3	R4	R5	R6	R7	R8	R9	R10	R11	R12	R13	R14	R15
70.8	74.3	68.0	71.8	68.6	59.5	83.4	64.9	0.0	32.0	67.5	12.3	72.2	82.0	71.2

CQS Q Values

Q1	Q2	Q3	Q4	Q5	Q6	Q7	Q8	Q9	Q10	Q11	Q12	Q13	Q14	Q15
57.6	62.5	53.6	68.2	79.6	85.3	75.1	59.4	46.4	29.9	34.4	72.3	87.5	83.9	72.1

CQS: 67.7 (Q1-Q8)

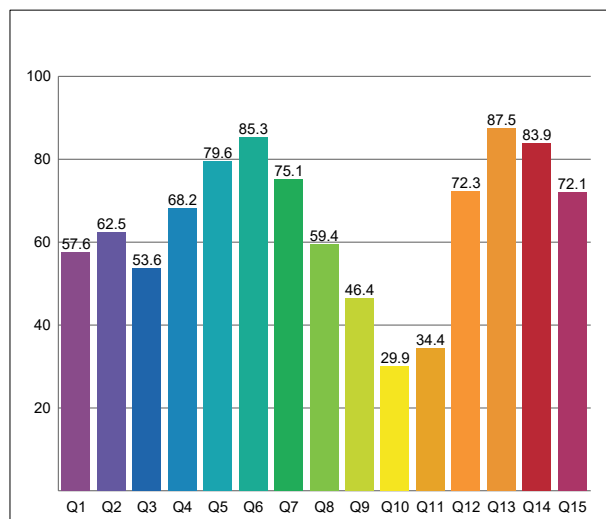

Colour Parameters

Color temperature	Color rendering index	Color fidelity	Color gamut	Color quality scale	Color coordinate cie 1931	Color coordinate cie 1931	Color coordinate	Color coordinate	Color deviation from black body
CCT	CRI	TM30 Rf	TM30 Rg	CQS	x	y	u	v	Δuv
9,154K	70.2	66	89	67.7	0.2875	0.2907	0.1944	0.4425	-0.0030

Foshan YiFeng Electric Industrial Co.,Ltd.

No.898, Gaoming Avenue East, Hecheng Blvd, Gaoming District, Foshan, Guangdong, China.

Web: www.acmelighting.com Email: sales@acmelighting.com

All rights reserved by Acme®. Features, specifications and appearance are subject to change without notice.

REV: 27/02/2026



PHOTON HYBRID 500

Outdoor Moving Laser Hybrid

SPEC SHEET

PHOTOMETRIC REPORT – TM-30

TM-30 Rf (IES TM-30-15 Fidelity Index): 66

TM-30 Rg (IES TM-30-15 Fidelity Index): 89

Hue Bin	Hue Angle	Graphic shift(%)		
		Rf	Chroma	Hue
1	0.0° - 22.5°	61	21	-1
2	22.5° - 45.0°	65	-15	11
3	45.0° - 67.5°	60	-8	23
4	67.5° - 90.0°	58	3	23
5	90.0° - 112.5°	74	3	10
6	112.5° - 135.0°	87	6	-2
7	135.0° - 157.5°	83	-6	-8
8	157.5° - 180.0°	71	-16	-4
9	180.0° - 202.5°	66	-22	16
10	202.5° - 225.0°	41	-23	37
11	225.0° - 247.5°	38	6	45
12	247.5° - 270.0°	45	7	28
13	270.0° - 292.5°	77	16	10
14	292.5° - 315.0°	76	9	-6
15	315.0° - 337.5°	64	10	-25
16	337.5° - 360.0°	75	-8	-11

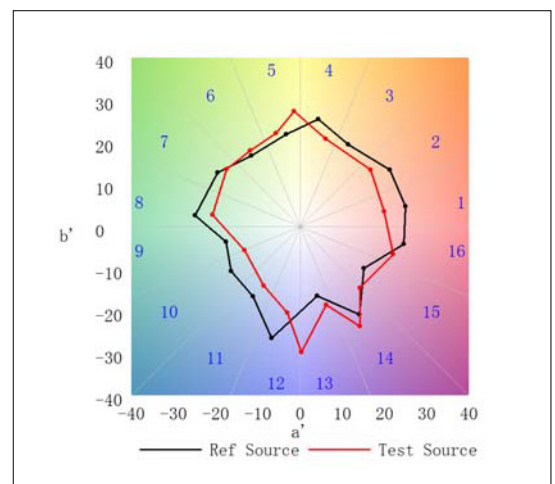
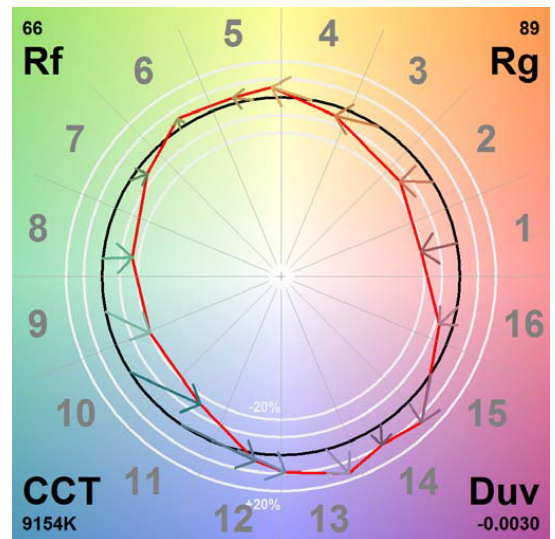
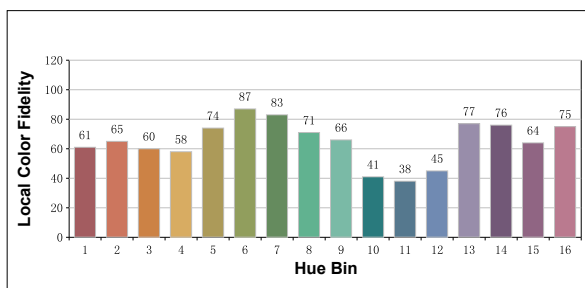
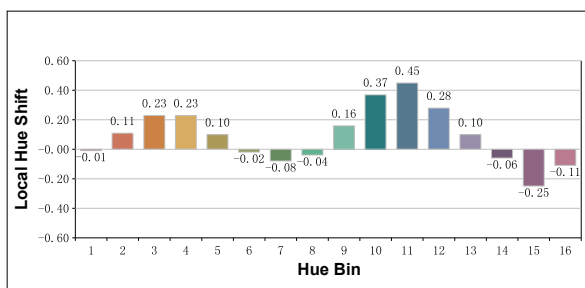
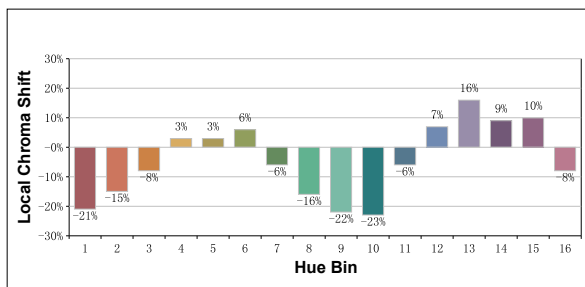
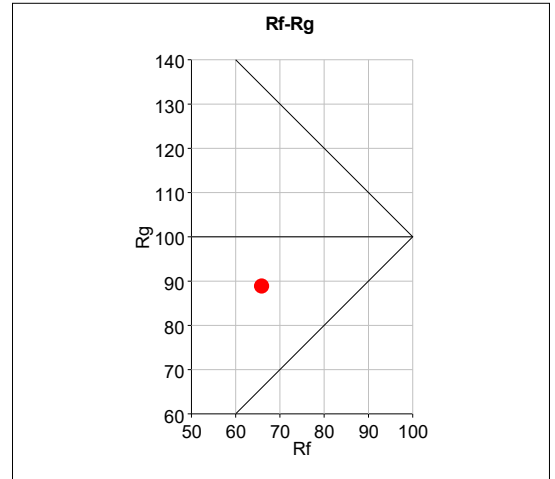

Foshan YiFeng Electric Industrial Co.,Ltd.

No.898, Gaoming Avenue East, Hecheng Blvd, Gaoming District, Foshan, Guangdong, China.

Web: www.acmelighting.com Email: sales@acmelighting.com

All rights reserved by Acme®. Features, specifications and appearance are subject to change without notice.

REV: 27/02/2026



PHOTON HYBRID 500

Outdoor Moving Laser Hybrid

SPEC SHEET

PHOTOMETRIC REPORT – TM-30

Color Evaluation Sample

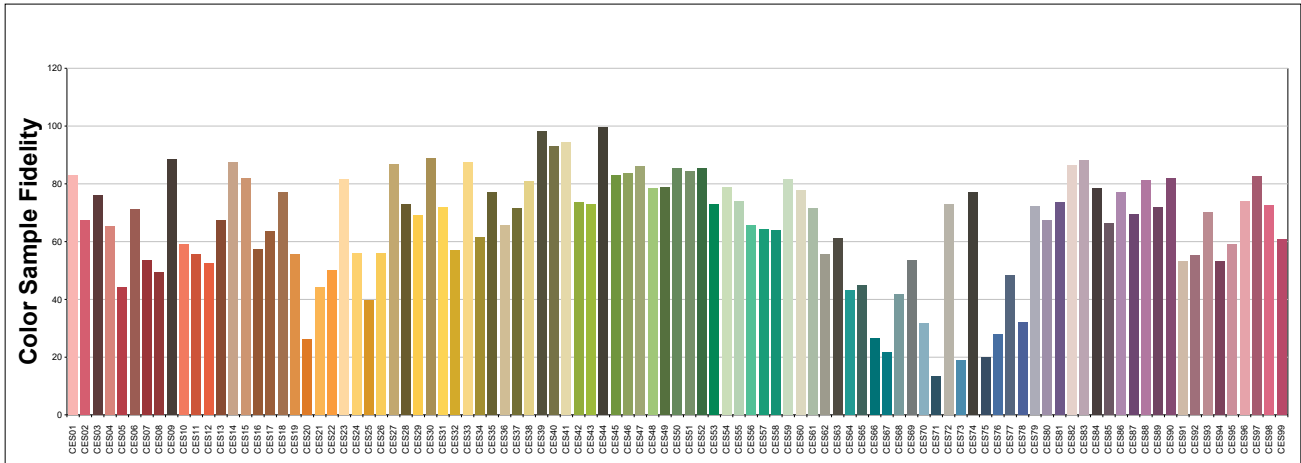

PHOTOMETRIC REPORT – TLCI-39

Color Evaluation Sample



Sector	Lightness	Chroma	Hue
R	5	4	2
R/Y	0	1	6
Y	-3	-3	-8
Y/G	-2	-3	0
G	-3	-3	3
G/C	1	1	4
C	3	0	-3
C/B	5	-1	-9
B	0	-5	-6
B/M	3	-3	3
M	6	0	7
M/R	6	2	4